

LOWRANCE®

www.lowrance.com

Pub. 988-0151-222



LMF-400

Multi-function Gauge

Installation and Operation

Instructions

**Copyright © 2006 Lowrance Electronics, Inc.
All rights reserved.**

No part of this manual may be copied, reproduced, republished, transmitted or distributed for any purpose, without prior written consent of Lowrance Electronics. **Any unauthorized commercial distribution of this manual is strictly prohibited.**

Lowrance Electronics may find it necessary to change or end our policies, regulations and special offers at any time. We reserve the right to do so without notice. All features and specifications subject to change without notice. On the cover: LMF-400.

**For free owner's manuals and other information,
visit our web site:**

www.lowrance.com

Lowrance Electronics Inc.
12000 E. Skelly Dr.
Tulsa, OK USA 74128-2486
Printed in USA.

Table of Contents

Section 1: Introduction	1
Section 2: Installation	3
Preparation.....	3
Recommended Tools and supplies.....	3
Installation Sequence.....	3
Mounting the Gauge.....	3
Connecting to a NMEA 2000 Network.....	5
Compatibility.....	5
Network Backbone and Network Nodes.....	5
Adding a Network Node.....	6
Additional NMEA information.....	7
Understanding this manual.....	8
Up and Down.....	8
Menu.....	8
Pages/Enter.....	8
Exit.....	8
Menu Commands.....	8
Instructions = Menu Sequences.....	8
Section 3: Operation	9
Boat Setup.....	9
Basic Menu.....	10
Pages.....	10
Viewing Pages (Page Screen Rotation).....	10
Page Options.....	11
Engine Trim.....	11
Diagnostics.....	11
Fuel Manager.....	11
GPS Position.....	11
Rudder.....	11
Single Analog.....	12
Dual Analog.....	12
Quad Analog.....	12
Single Digital.....	12
Dual Digital.....	12
Quad Digital.....	12
Synchronizer.....	12
Trim Tabs.....	13
Pages Menu.....	13
Add Page.....	13
Remove Page.....	14
Page Scrolling.....	14

Pop-Ups Setup	14
Screen.....	16
Backlight.....	16
Backlight Sync (BLight Sync).....	17
Contrast	17
Reverse Video	18
Audio Setup	18
Key Sounds	18
Alarm Sound.....	19
System Setup Menu	19
Engine Data.....	19
Engine Warnings.....	19
Bus Devices.....	20
Sonar Alarms	20
Engine/Tank Configuration	21
Reset Values:	22
NMEA Info.....	23
System Information.....	23
Speed Range	23
Pressure Ranges	23
Change Units.....	24
Fuel Setup.....	26
Refill Tank	26
Partial Fill.....	27
Economy Speed Source	27
Fuel Remaining Source.....	28
Reset Trip Fuel.....	28
Reset Seasonal.....	29
Customizing Pages	29
Single Analog.....	30
Dual Analog	31
Quad Analog	31
Single Digital.....	32
Dual Digital	32
Quad Digital	34
Trim Tabs.....	35
Fuel Manager	35
Section 4: EP Configuration & Calibration.....	37
EP-35 Temperature Configuration	37
EP-10 Fuel Flow Configuration	39
EP-15 Fluid Level Configuration	42
Fluid Level menu	43
Reset Values	47

Suzuki Engine Interface Configuration.....	48
Calibrating EP Sensors.....	51
Calibrating EP-10 Fuel Flow.....	52
Fuel Flow Accuracy	52
Refill Tank	52
Reset Calibration.....	54
Partial Fill.....	54
Calibrating EP-15 Fluid Level	54
2-Point Calibration.....	55
3-Point Calibration.....	55
5-Point Calibration.....	56
Reset Calibration.....	57
Calibrating Fuel Flow in a Suzuki Engine Interface.....	58
Engine Interface Accuracy.....	58
Refill Tank	59
Reset Fuel Calibration	60
Partial Fill.....	60
Calibrating EP-30 Trim Tabs.....	61

Notes

Section 1: Introduction

Thank you for buying the Lowrance® LMF-400! Your unit is a high-quality, multi-function, digital gauge designed to work with a LowranceNET™ network. This is the NMEA 2000® networking system developed by Lowrance Electronics.

Caution:

*Installing LowranceNET NMEA 2000 devices is **significantly different** from installing earlier Lowrance components without NMEA 2000 features. You should read all of the installation instructions before proceeding.*

This gauge will *only* work with a NMEA 2000 network. It **MUST** be connected to a NMEA 2000 network or it **WILL NOT** function. When properly installed, the LMF-400 will display information from a variety of Lowrance Electronic Probe (EP) sensors and other NMEA 2000 devices connected to the network.

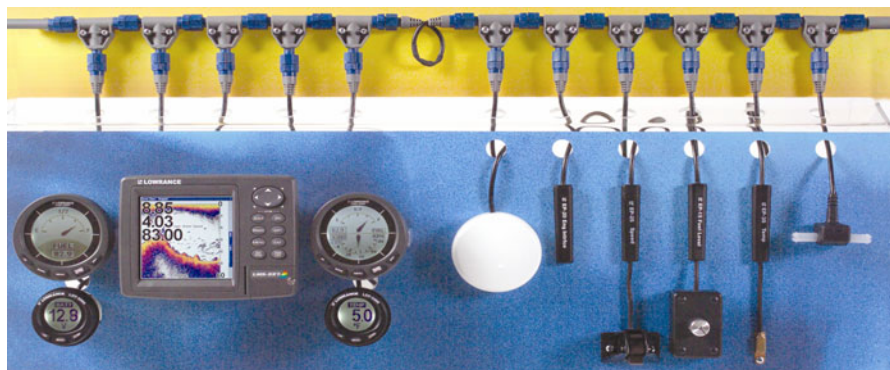

A NMEA 2000 network using LowranceNET components.

All Lowrance NMEA 2000 capable devices are either NMEA 2000 certified or certification is pending. See our web site, www.lowrance.com, for the latest product information.

To get started with your Lowrance gauge, read Section 2: Installation. After you have read those instructions, install the gauge and any EP sensors you may have purchased, then read the rest of this manual. Each sensor comes with its own installation instruction sheet, but this manual describes how the gauge operates with each sensor and how to configure and calibrate the sensors.

Your gauge packaging also includes the *NMEA 2000 Networks General Information*. It contains instructions for creating or expanding a NMEA 2000 network.

LowranceNET teams up the powerful NMEA 2000 network standard with a fast-growing, cutting-edge family of Lowrance Electronic Probe Sensors. The product line includes the EP-10 Fuel Flow, EP-15 Fluid Level, Suzuki Engine interface, EP-25 Speed, EP-35 Temp, EP-45 Pressure sensors and EP-50 Storage device.

And what's more exciting, there are others on the way. Be sure to log on to our website, www.lowrance.com, from time to time for the latest developments, including updated operation manuals, instruction sheets and software you can download free of charge. When you are ready to expand your network, see the accessory ordering information on the back cover of this manual.

NOTICE!

The storage and operation temperature range for your unit is from -4 degrees to +167 degrees Fahrenheit (-20 degrees to +75 degrees Celsius). Extended storage or operation in temperatures higher or lower than specified will damage the liquid crystal display in your unit. This type of damage is not covered by the warranty. For more information, contact the factory's Customer Service Department; phone numbers are inside the manual's back cover.

Section 2: Installation

Preparation

The design of the LMF-400 allows convenient mounting in the dash of your boat, or it can be mounted on any flat panel at least four inches in diameter.

To mount the LMF-400 in the dash, first make sure there is sufficient clearance behind the panel in the desired location. At least 3-1/2 inches are needed behind the surface of the dash to clear all connectors and wiring.

Recommended Tools and supplies

Recommended tools for this job include: hole saw, 3/38" (86 mm) hole saw bit, drill, 1/8" (3 mm) drill bit (for starter hole). Required supplies for this job include: "U" bracket, lock washers and wing nuts (included).

Installation Sequence

You can install this gauge in some other order if you prefer, but we recommend the installation sequence listed below.

1. Determine the location for the gauge so you can plan how and where to route the cables. This will help you make sure you have enough cable length for the desired configuration.
2. Determine the location of the nearest device on the boat's NMEA 2000 network, along with the route of the gauge's network cable.
3. Determine the location for the alarm buzzer and its wire route.
4. If you want the gauge's backlight to turn on when the dashboard lights are turned on, locate your boat's dash light switch and determine how to route the gauge's dash light wires to it.
5. Install the gauge in a standard 3-3/8 inch (86 mm) hole in the dash. If no 3-3/8 hole available in the dash, you will have to drill a 1/8" pilot hole, then use a hole saw to cut a mounting hole. See instructions for Mounting the Unit below.
6. Connect the buzzer wires and install the buzzer. If desired, connect the dash light wires to the boat's dash light switch.
7. Connect the network cable to the NMEA 2000 network.

Mounting the Gauge

If no standard mounting hole is available in the dash, drill a 1/8" pilot hole, then cut a 3-3/8 inch (86 mm) diameter mounting hole with a hole saw. A "U" bracket is supplied to hold the unit to the dash. Place it over the threaded studs on the back of the unit and secure it with the lock washers and nylon wing nuts provided with the unit.

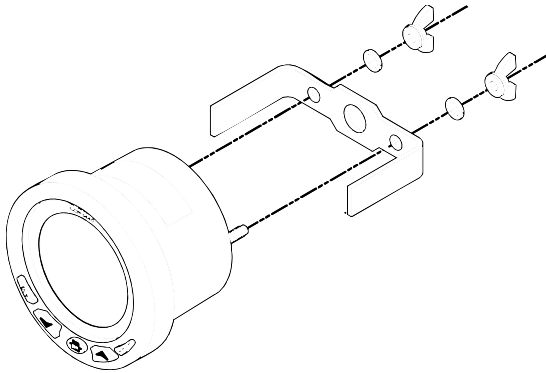

Secure unit to the dash using "U" bracket as shown.

The bracket is designed to secure the unit to a dash with a thickness of 2 mm. If your dash is thicker than 2 mm, the "U" bracket will be too long. Simply place washers or spacers between the unit and the bracket until you can tighten the wing nuts and secure the unit in place. You are now ready to wire the unit to the buzzer (piezo) and dash lights.

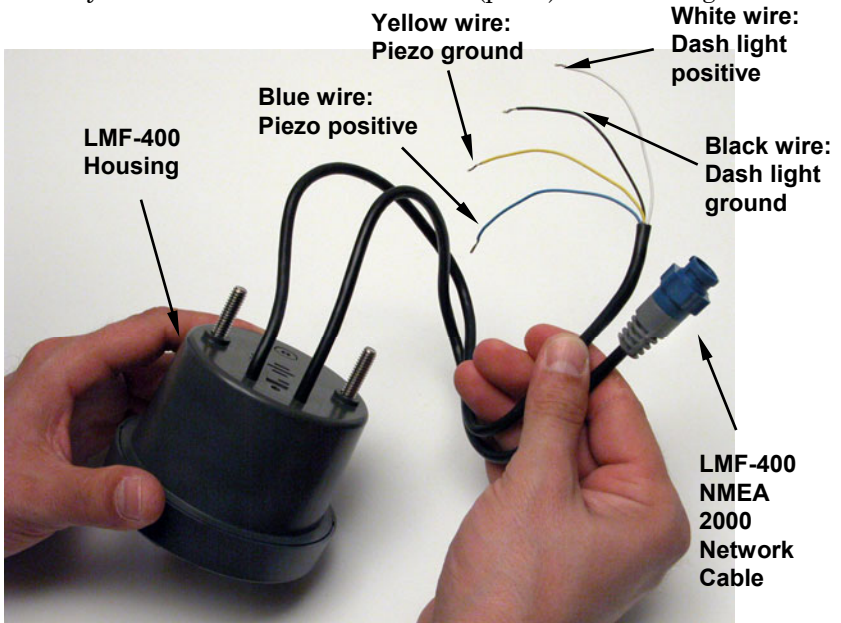

LMF-400 with power cable wiring and NMEA 2000 Cable Connection.

Connecting the LMF-400 to the buzzer (piezo), will enable the buzzer to sound when buttons are pressed and when alarms and level warnings are triggered. Wiring the unit to the boat's dash lights, will turn on the LMF-400 backlight when the dash lights are turned on.

If you do not want to use the buzzer or dash light wires, clip the bare ends off the wires, then cap them with wire nuts or electrical tape.

To wire unit to the buzzer (piezo):

1. Connect the LMF-400 yellow wire to the buzzer (piezo) ground wire.
2. Attach the LMF-400 blue wire to the buzzer (piezo) positive wire.
3. Select a buzzer location that is protected from the elements, but will still allow you to hear it. Use the adhesive back on the buzzer to mount the buzzer to a flat, clean surface.

To wire unit to dash lights:

1. Connect the LMF-400 black wire to the dash light ground wire.
2. Now attach the LMF-400 white wire to the dash light positive wire.

Connecting to a NMEA 2000 Network

A network bus is an installed and operational network cable (backbone) running the length of your boat, already connected to a power supply and properly terminated. It provides network connection nodes at various locations around your boat.

Compatibility

You will easily be able to connect your unit to both red (DeviceNet) and blue connector networks, regardless of whether your unit has a blue or red connector network cable. Check the adapter cable segment in the *Setup and Installation of NMEA 2000 Networks, General Information*" that came packed with your unit. If you do not have that document, it can be downloaded free from the Lowrance web site.

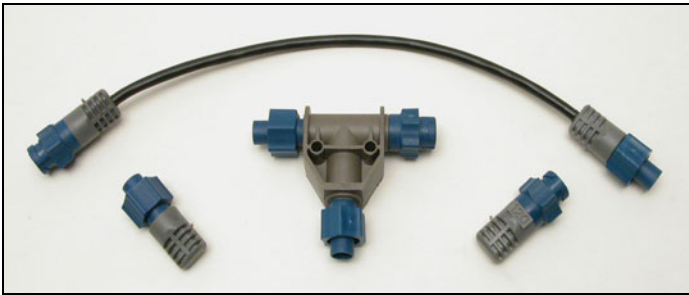

LowranceNET Node Kit for a NMEA 2000 network. Includes a 2 foot extension cable, T connector, 120-ohm male terminator and 120-ohm female terminator.

Network Backbone and Network Nodes

A network bus backbone consists of network cabling, terminators and T connectors. Network nodes are made by fitting T-shaped connectors into the backbone (using the sockets on the sides) and attaching any network device to the bottom of the T.

Adding a Network Node

You can add a node to any existing connection, anywhere along the network backbone. This connection could be between a T connector and a terminator, between two T connectors, between a T connector and a backbone extension cable or between two extension cables. Wherever you want to add the new node, separate the sockets of the existing connection and install the T connector between them.

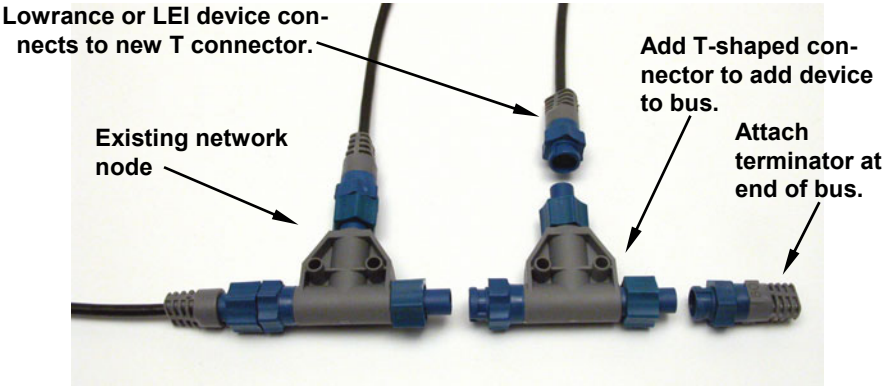

Add a new device to a NMEA 2000 bus (above) by attaching a T connector between two T connectors, between a T connector and the end terminator, or between two backbone extension cables. The red connector network (below) is built in the same way. Notice the Double T connectors on the red connector network.

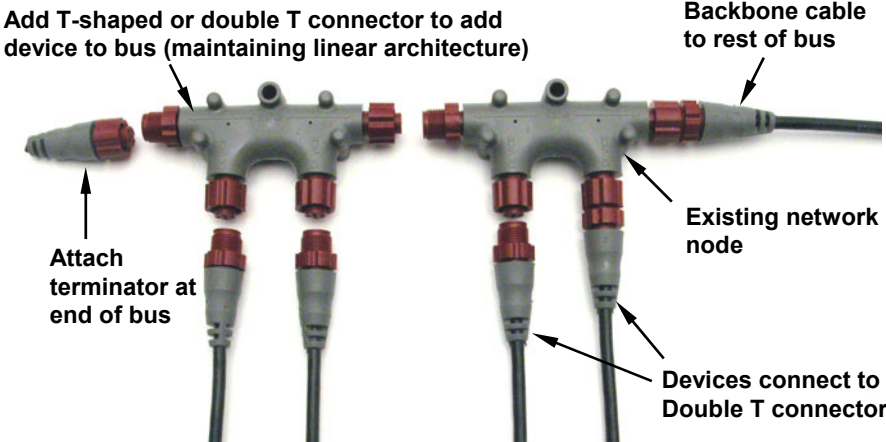

If you want to add a node at the end of the backbone (network bus) remove the terminator from the last connector, like the figure above. Install the new T connector, then attach the terminator to the side of the connector.

NOTE:

If you add an EP-10 Fuel Flow, EP-15 Fluid Level, EP-45 Water Pressure or EP-50 Storage Device sensor to the network, you must go through Boat Setup so the engine-tank configuration will be consistent among the sensors in the LowranceNet. Follow the Boat Setup procedure included in Section 3: Operation.

Additional NMEA information

For more detailed information about setting up a NMEA 2000 network, refer to the "*Setup and Installation of NMEA 2000 Networks, General Information*" that came with your unit. If you do not have that document, it can be downloaded free from the Lowrance web site.

Understanding this manual

Most instructions in the manual are listed as numbered steps. Keypad commands appear as boldface type, making it easy to skim through instructions and pick out what command to use.

Up and Down

The Up and Down keys help you navigate through menus, select (highlight) menu items, and are used to make adjustments to numbers in dialog boxes. They are shown as **UP** and **DOWN** in this manual.

Menu

When instructed to press the menu key, menu will be shown as **MENU**. The menu key is used to access the main menu.

Pages/Enter

The Pages/Enter key is used to execute commands and to scroll forward through pages set for display on the main screen. The Pages/Enter key will be shown as **ENTER** in this manual.

Exit

The Exit key is used to close menus and remove dialogs, windows and messages from the screen. Shown as **EXIT** in this manual, it is also used to scroll backward through pages set for display on the main screen.

Menu Commands

A menu command or a menu option will appear in small capital letters, like — **SYSTEM SETUP**. When you see a word in command text, you are supposed to take action, by selecting (highlighting) this command or option from a menu.

Instructions = Menu Sequences

Most functions performed with this unit are described as a sequence of keystrokes.

Instructions for accessing a menu will look like this:

1. To access the Bus Devices list, press **MENU**, use the **UP** and **DOWN** keys to select **SYSTEM SETUP** and press **ENTER**.
2. Highlight **BUS DEVICES** and press **ENTER**. The Bus Devices list will appear, showing all devices on your NMEA 2000 network.

Section 3: Operation

The displays and settings in this digital gauge are controlled by a five-button keypad. The buttons are **UP**, **DOWN**, **MENU**, **ENTER** and **EXIT**. The **MENU** key gives you access to the basic menu. The **UP** and **DOWN** keys are used to scroll through and highlight menu items. The **PAGES/ENTER** key (also referred to as the **ENTER** key) allows you to scroll forward through pages, execute commands and select items from menus. The **EXIT** key is used to close menus and scroll backward through pages.



LMF-400 keypad.

Boat Setup

When the LMF-400 is turned on the first time, the Boat Setup menu will appear. You will not be able to proceed without completing Boat Setup. If, however, you have one or more of the following devices — Suzuki Engine Interface, EP-10 Fuel Flow, EP-15 Fluid Level, EP-45 Pressure Sensor or an EP-50 Storage Device — already configured in the network with the same engine-tank configuration, you **WILL NOT** have to go through boat setup when adding a new gauge to the network. After adding the gauge to the network, the Boat Setup menu will be cleared from the screen and the unit will begin normal operation in 1-2 seconds.

NOTE:

If you add an EP-10 Fuel Flow, EP-15 Fluid Level, EP-45 Water Pressure or EP-50 Storage Device sensor to the network, you must go through Boat Setup so the engine-tank configuration will be consistent among sensors on the network.

To execute Boat Setup:

1. With Boat Setup highlighted on the screen, press **ENTER**. A menu will appear, allowing you to choose the number of engines and fuel tanks on your vessel. The Boat Setup menu options are: 1 Eng/1 Tank, 1 Eng/2 Tank, 2 Eng/1 Tank, 2 Eng/2 Tanks, 3 Eng/1 Tank or 3 Eng/3 Tanks.

2. Use the **UP** and **DOWN** keys to select the engine-tank configuration that applies to your vessel and press **ENTER**. After setting the engine/tank configuration, the Tank Size menu will appear with up to three options (Port Tank, Center Tank and Starboard Tank), depending on the engine tank configuration you chose. (If you selected one tank during Boat Setup, you will be taken directly to the Setting Tank Size Window in Step 4.)

3. Select the desired tank and press **ENTER**, which will open the Setting Tank Size window.

4. Use the **UP** and **DOWN** keys to input the number of gallons the tank will hold and press **ENTER**.

Press **EXIT** and repeat steps 3 and 4 for each of the remaining tanks.

5. After all tanks on your vessel have been set up, press **EXIT** repeatedly to get back to the main display.

NOTE:

If you chose the wrong engine-tank configuration during Boat Setup, you will have to reset your engine-tank configuration to get back to Boat Setup. To reset engine-tank configuration, see engine-tank configuration instructions on page 21.

Basic Menu

The LMF-400 has 13 page screens that can be customized with the data of your choosing. Each page has its own basic menu. Basic menus vary from page to page, but all contain these standard menu options: Pages, Screen, Audio Setup and System Setup. Pages that can be customized also include Customize on the basic menu.

Pages

Your unit can display up to 16 page screens. You could, for example, add 12 different pages then add some pages more than once, customizing them differently each time.

Viewing Pages (Page Screen Rotation)

The Page Screen Rotation consists of multiple pages that have been set up for display. Once pages have been added to the page screen rotation, they can be set to scroll across the screen automatically or manually. Use the **ENTER** and **EXIT** keys to manually scroll pages across the screen. Pressing the **ENTER** key moves the scroll in one direction. Pushing the **EXIT** key moves the scroll in the other direction. You will use the Page Scrolling feature to set up pages for automatic scrolling. See page 14 for more information about Page Scrolling.

Page Options

The LMF-400 has 12 different pages that may be added to the page screen rotation. They are: Engine Trim, Diagnostics, Fuel Manager, GPS Position, Single Analog, Dual Analog, Quad Analog, Single Digital, Dual Digital, Quad Digital, Synchronizer, Trim Tabs and Rudder.

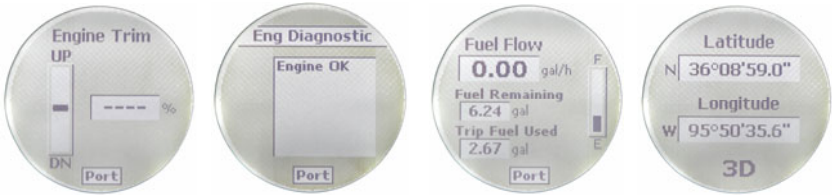

Engine Trim (from left to right), Diagnostics, Fuel Manager and GPS Module page.

Engine Trim

The Engine Trim page displays engine position data as an analog slider bar and as a percentage. It cannot be customized.

Diagnostics

The Engine Diagnostic page displays engine performance data. It cannot be customized.

Fuel Manager

The Fuel Manager page has a digital readout capable of displaying nine data types, including fuel flow, fuel used and fuel remaining.

GPS Position

The GPS position page displays the boat's position in Latitude-Longitude, using Degrees-Minutes or Degrees-Minutes-Seconds as the units of measure.

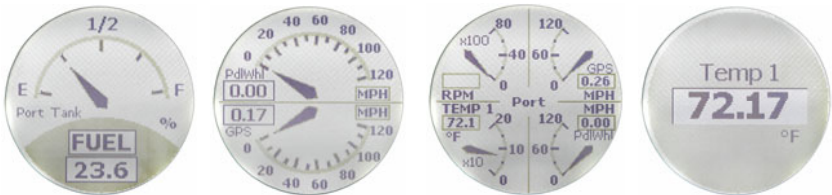

Single Analog (from left to right), Dual Analog, Quad Analog and Single Digital page.

Rudder

The Rudder Page displays the rudder position as an analog gauge and in degrees. It cannot be customized.

Single Analog

The Single Analog page consists of a single analog gauge that can be customized to display a wide assortment of data, ranging from Alternator Voltage and Water Speed to Battery Voltage and Tachometer.

Dual Analog

The Dual Analog page features two analog gauges stacked one on top of the other. Both gauges can be customized to display a wide assortment of data including, Atmospheric Pressure, Engine Boost Pressure, Fuel Pressure and Fluid Level.

Quad Analog

The Quad Analog page is divided equally into four parts, each containing a small analog gauge. All four gauges can be customized to display a wide range of data, from Pitot Speed and Engine Temperature to Oil Pressure and Transmission Oil Pressure.

Single Digital

The Single Digital page consists of a digital data box that can be customized to display a wide assortment of data that includes Battery Voltage, Water Speed and Tachometer.

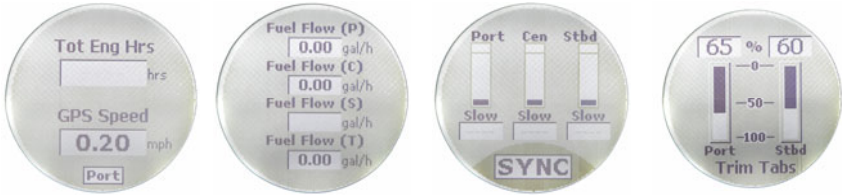

Dual Digital (from left to right), Quad Digital, Synchronizer and Trim Tabs page.

Dual Digital

The Dual Digital page features two digital data boxes that can be customized to display a wide assortment of data including, Engine Oil Pressure, Engine Load and Total Engine Hours.

Quad Digital

The Quad Digital page has four customizable digital data boxes stacked one on top of the other capable of displaying a wide range of data, from Seasonal Fuel and Fuel Used to Depth and Temperature.

Synchronizer

The Synchronizer page displays RPM for up to three engines. It allows users to synchronize engines for smoother performance. The Synchronizer page cannot be customized and will NOT be available for single-engine configurations.

Trim Tabs

The Trim Tab page monitors the position of the Trim Tabs using degrees or percentages as units of measure.



Scrolling list of page options (left) with basic menu options (right).

Pages Menu

The Pages menu can be accessed from any of the page displays. It has four options: Add Page, Remove Page, Page Scrolling and Pop-Ups Setup.

Add Page

The Add Page command allows you to add pages to the page screen rotation. Pages that are not added to the page screen rotation will not be displayed.

NOTE:

Only pages added to the page screen rotation will be displayed.

To add a page to the display:

1. Press **MENU**, use the **UP** and **DOWN** keys to select **PAGES** and press **ENTER**. A menu will pop up with four options: Add Page, Remove Page, Page Scrolling and Pop-Ups Setup.
2. Select **ADD PAGE** and press **ENTER**.
3. Highlight the page you want to display and press **ENTER**. The following message will appear: *Press Enter to add the selected page.*
4. Press **ENTER**, which will take you back to the main display, where the page you chose will be shown on the screen.

NOTE:

The LMF-400 can have up to 16 pages in the page screen rotation at one time. If you try to add a 17th page, the following message will appear: *Number of Pages has Reached Max.* In that case, you will have to remove a page before another page can be added to the page screen rotation.

Remove Page

The Removing Pages command allows you to remove pages from the page screen rotation. Before selecting Remove Pages, make sure the page you want to remove is displayed on the screen.

To remove a page from the display:

1. First, scroll the page you want to remove on to the screen. Press **MENU**, use the **UP** and **DOWN** keys to select **PAGES** and press **ENTER**.
2. Highlight **REMOVE PAGE** and press **ENTER**. The following message will appear: *Press Enter to Remove current Page.*
3. Press **ENTER**, which will take you back to the main display.

Page Scrolling

Once all the pages you want to monitor have been added to the page screen rotation, you will be able to view them in two ways. You can scroll through pages manually by using the **ENTER** and **EXIT** keys or utilize the Page Scrolling function to have pages automatically scroll across the screen at an interval of your choosing.

To activate Page Scrolling:

1. Press **MENU**, use the **UP** and **DOWN** keys to select **PAGES** and press **ENTER**.
2. Select **PAGE SCROLLING** and press **ENTER**. The Page Scrolling menu will appear with two settings: Off and Set Time.
3. Highlight **SET TIME** and press **ENTER**. (You would select **OFF** to turn off Page Scrolling.)
4. Use the **UP** and **DOWN** keys to select an interval between one and 60 seconds and press **ENTER**. You will be taken back to the main display.

Pop-Ups Setup

This feature helps you keep tabs on the RPM, Engine Trim, Trim Tab and Rudder pages by launching a pop up window if selected thresholds for any of the data types are exceeded. If, for example, you set the RPM threshold to 500 RPM and choose a 10-second Stay on Time, the RPM page will pop up if there is a change in RPM that exceeds 500 RPM — like decreasing RPM from 2000 RPM to 1300 RPM. The pop up will expire 10 seconds after the data that exceeded the threshold stops changing. The gauge will revert to the page it was showing before the threshold was exceeded.

To set RPM Pop up:

1. Press **MENU**, use the **UP** and **DOWN** keys to select **PAGES** and press **ENTER**.
2. Highlight **POP-UPS SETUP** and press **ENTER**.

3. The Pop-Ups Setup menu will appear with five options: RPM, Engine Trim, Trim Tabs, Rudder and Stay-on Time. Select **RPM** and press **ENTER**. The RPM menu will appear with two options: Off and Set Threshold.

4. Highlight **SET THRESHOLD** and press **ENTER**. (You would select **OFF** to turn off the pop-up.)

NOTE:

In a multiple engine configuration, the next step would be to select the engine.

5. Use the **UP** and **DOWN** keys to select a threshold between 50 and 3,000 RPM and press **ENTER**. You will be taken back to the main display.

To set Engine Trim Pop-up:

1. Press **MENU**, use the **UP** and **DOWN** keys to select **PAGES** and press **ENTER**.

2. Highlight **POP-UPS SETUP** and press **ENTER**.

3. Select **ENGINE TRIM** and press **ENTER**. The Engine Trim menu will appear with two options: Off and Set Threshold.

4. Highlight **SET THRESHOLD** and press **ENTER**. (You would select **OFF** to turn off the pop-up.)

5. Use the **UP** and **DOWN** keys to select a threshold between 3% and 50% and press **ENTER**. You will be taken back to the main display.

To set Trim Tabs Pop up:

1. Press **MENU**, use the **UP** and **DOWN** keys to select **PAGES** and press **ENTER**.

2. Highlight **POP-UPS SETUP** and press **ENTER**.

3. Select **TRIM TABS** and press **ENTER**. The Trim Tabs menu will appear with two options: Off and Set Threshold. (You would select **OFF** to turn off the pop-up.)

4. Highlight **SET THRESHOLD** and press **ENTER**.

5. Use the **UP** and **DOWN** keys to select a threshold between 3% and 50% and press **ENTER**. You will be taken back to the main display.

To set Rudder pop-up:

1. Press **MENU**, use the **UP** and **DOWN** keys to select **PAGES** and press **ENTER**.

2. Highlight **POP-UPS SETUP** and press **ENTER**.

3. Select **RUDDER** and press **ENTER**. The Rudder menu will appear with two options: Off and Set Threshold.

4. Highlight **SET THRESHOLD** and press **ENTER**. (You would select **OFF** to turn off the pop-up.)

5. Use the **UP** and **DOWN** keys to select a threshold between 3 and 40 degrees. Press **ENTER**. You will be taken back to the main display.

Stay-On Time:

The Stay-On Time command allows you to choose how long a pop-up will remain on the screen after the data stops moving. The Stay-On Time setting will affect all four Pop-up Pages.

1. Press **MENU**, use the **UP** and **DOWN** keys to select **PAGES** and press **ENTER**.
2. Highlight **POP-UPS SETUP** and press **ENTER**.
3. Select **STAY-ON TIME** and press **ENTER**.
4. Use the **UP** and **DOWN** keys to input the amount of time a pop up will remain on the screen. The stay-on time for a pop up may be set between 2 and 15. Press **ENTER**. You will be taken to the main display.



Basic menu with Screen highlighted (left). Screen option menu (center) with Set Backlight window (right).

Screen

Accessing the Screen menu allows you to make adjustments to the appearance of the screen. There are three options: Backlight, Contrast and Reverse Video.

Backlight

The Backlight feature allows you to brighten or dim the light in the LMF-400.

To adjust Backlight:

1. Press **MENU**, use the **UP** and **DOWN** keys to select **SCREEN** and press **ENTER**.
2. Highlight **BACKLIGHT** and press **ENTER**. The Backlight menu will appear with two options: BLight Sync (Backlight Sync) and Adjust.
3. Select **ADJUST** and press **ENTER**.
4. A vertical scrollbar will appear. Use the **UP** and **DOWN** keys to set the backlight to a desired level. Press **EXIT** to return to the Backlight menu.

Backlight Sync (BLight Sync)

By turning on the Backlight Sync function, all the backlight levels for components on the LowranceNet may be controlled by any of the gauges or head units in the network. If you adjust the backlight on one of the gauges or display units, the backlight levels from the other gauges and display units will be changed, too. Backlight Sync will be on by default.

To set Backlight Sync:

1. Press **MENU**, use the **UP** and **DOWN** keys to select **SCREEN** and press **ENTER**.
2. Highlight **BACKLIGHT** and press **ENTER**. The Backlight menu will appear with two options: BLight Sync (Backlight Sync) and Adjust.
3. Highlight **BLIGHT SYNC** and press **ENTER**, which will open the BLight Sync menu with two options: On and Off. Turning on Backlight Sync will cause the backlight level for all gauges on the LowranceNet to be synchronized with the backlight level on your LMF-400.
4. Select the desired option (**ON** or **OFF**) and press **ENTER** to be directed to the main display.

Contrast

The Contrast feature allows you to darken or lighten the display screen. If you have more than one gauge, each gauge's contrast is adjusted individually. Contrast is not synchronized over the network.

To adjust Contrast:

1. Press **MENU**, use the **UP** and **DOWN** keys to select **SCREEN** and press **ENTER**. Select **CONTRAST** from the Screen menu and press **ENTER**, which will launch the Contrast Adjustment vertical scrollbar.
2. Use the **UP** and **DOWN** keys to move the bar to a desired level.
3. Press **EXIT** to return to the Screen menu or press **ENTER** to return to the main display.



Contrast is highlighted on the Screen menu (left). The Contrast Adjust window (center). Reverse Video highlighted on Screen menu (right).

Reverse Video

The Reverse Video function swaps the position of dark and light colors on the screen. The dark text, which is on top of a light background, will be switched to light text on top of a dark background. This feature, typically, is used to darken the display for nighttime use.

NOTE:

The Reverse Video command is transmitted over the network, so all gauges will be synchronized to the same Reverse Video setting.

To turn on Reverse Video:

1. Press **MENU**, use the **UP** and **DOWN** keys to select **SCREEN**, and press **ENTER**.
2. Highlight **REVERSE VIDEO** and press **ENTER**. You will notice the dark and light colors have been swapped for one another.
3. To switch Reverse Video to its previous setting, return to the Screen menu, select **REVERSE VIDEO** and press **ENTER**.
4. Press **EXIT | EXIT** to return to the main display.



Audio Setup highlighted on the basic menu (left). Audio Setup menu (center) with Key Sounds menu (right).

Audio Setup

Audio Setup gives you access to the unit's audio functions. There are two options on the Audio Setup menu: Key Sounds and Alarm Sounds.

Key Sounds

When Key Sounds are turned on, a tone will sound every time you push the **UP**, **DOWN**, **MENU**, **ENTER** and **EXIT** keys. When you turn off Key Sounds, no tone will sound when you depress the keys.

To turn Key Sounds on/off:

1. Press **MENU**, use the **UP** and **DOWN** keys to select **AUDIO SETUP**, and press **ENTER**. A menu will appear with two options: Key Sounds and Alarm Sound.
2. Select **KEY SOUNDS** and press **ENTER**. The Key Sounds menu will appear with two options: On and Off.

3. Highlight **ON** to turn Key Sounds on or **OFF** to turn Key Sounds off. Press **ENTER**. You will be taken back to the main display.

Alarm Sound

When an alarm is set and Alarm Sound is turned on, you will hear a tone and see a pop-up window when an alarm is triggered. With an alarm set and Alarm Sound turned off, you will see a pop-up window, but no tone will sound.

To turn Alarm Sound on/off:

1. Press **MENU**, use the **UP** and **DOWN** keys to select **AUDIO SETUP** and press **ENTER**. A menu will appear with two options: Key Sounds and Alarm Sound.
2. Highlight **ALARM SOUNDS** and press **ENTER**. The Alarm Sound will appear with two options: On and Off.
3. Select **ON** to turn on Alarm Sound or select **OFF** to turn off Alarm Sound. Press **ENTER**. You will be taken back to the main display.

System Setup Menu

The System Setup menu contains the following features: Engine Data, Engine Warnings, Change Units, Fuel Setup, Bus Devices, Sonar Alarms, Eng/Tank Configuration, Reset Values, NMEA Information and System Information. Speed Range and Pressure Range are included on the System Setup menu on the Synchronizer, Engine Trim, Single Analog and Trim Tab pages.

Engine Data

The Engine Data feature allows you to select an engine (Port, Center or Starboard) to be the primary engine shown on pages that display engine data.

To modify Engine Data:

1. Press **MENU**, select **SYSTEM SETUP** and press **ENTER**.
2. Highlight **ENGINE DATA** and press **ENTER** to open the Select Engine menu with three options (Port, Center and Starboard), depending on the engine-tank configuration you chose.
3. Select the engine (Port, Center or Starboard) you want to have displayed and press **ENTER**. A confirmation message will appear. If, for example, you selected the Port engine the following message will appear: *Press Enter to change to Port Engine.*
4. Press **ENTER**. Pages that display engine data will now show data from the selected engine. You will be taken back to the main display.

Engine Warnings

The Engine Warnings feature allows you to set an alarm for one or more engines. There are up to five options in the Engine Alarms menu,

depending on the number of engines chose during Boat Setup. The options are All Engines, Port, Center, Starboard and Off. The default setting is All Engines. (If you have a single-engine configuration, the only options on the Engine Warning menu will be on and off.)

1. Press **MENU**, use the **UP** and **DOWN** keys to highlight **SYSTEM SETUP**, and press **ENTER**.
2. Highlight **ENGINE WARNINGS** and press **ENTER** to access the Engine Warnings menu.
3. Choose the desired option and press **ENTER**. You will be taken back to the main display. If you choose All Engines, the alarm will be shown for each alarm that has been set. If Port, Center or Starboard engines are selected, the gauge will only show warnings coming from the chosen engine. (To turn off all engine warnings, highlight **OFF** and press **ENTER**. If you turn off engine alarms, no alarms will be shown for any of the engines.)

Bus Devices

The Bus Devices feature allows you to manage devices on the NMEA 2000 network. Accessing devices from the Bus Devices list gives you access to an EP sensor's internal menu. We will cover that in more detail in Section 4: EP Configuration and Calibration.

1. Press **MENU**, use the **UP** and **DOWN** keys to select **SYSTEM SETUP** and press **ENTER**.
2. Highlight **BUS DEVICES** and press **ENTER**. The Bus Devices, a list of network devices, will appear.
3. Press **EXIT** repeatedly to get back to the main display.

Sonar Alarms

Sonar alarms allow you to set alarms that will alert you as water depth changes around your vessel. If the depth rises above (Deep Alarm) or falls below (Shallow Alarm) thresholds of your choosing, an alarm will sound.

To set the Shallow Alarm:

The shallow alarm will sound when your vessel enters water more shallow than the selected shallow alarm threshold.

1. Press **MENU**, use the **UP** and **DOWN** keys to select **SYSTEM SETUP** and press **ENTER**.
2. Highlight Sonar Alarms and press **ENTER** to open the Sonar Alarms menu with two options: Shallow and Deep.
3. Select **SHALLOW** and press **ENTER**. The Shallow menu will appear with two options: Off and Set Depth.

4. Select **SET DEPTH** and press **ENTER** to open the Set Depth menu. (Choose **OFF** to turn off the Shallow Alarm).
5. Use the **UP** and **DOWN** keys to set the alarm to the desired depth and press **ENTER**. Press **EXIT** to return to the Sonar Alarms menu.

To set the Deep Alarm:

The deep alarm will sound when your vessel enters water deeper than the selected deep alarm threshold.

1. Press **MENU**, use the **UP** and **DOWN** keys to select **SYSTEM SETUP** and press **ENTER**.
2. Highlight Sonar Alarms and press **ENTER** to open the Sonar Alarms menu with two options: Shallow and Deep.
3. Select **DEEP** and press **ENTER**. The Shallow menu will appear with two options: Off and Set Depth.
4. Select **SET DEPTH** and press **ENTER**. (Choose **OFF** to turn off the Deep Alarm).
5. Use the **UP** and **DOWN** keys to set the alarm to the desired depth, then press **EXIT** repeatedly to get back to the main display.



Sonar Alarms highlighted on System Setup menu (left). Sonar Alarms menu (center); Reset Values selected on System Setup menu (right).

Engine/Tank Configuration

The Engine/Tank configuration menu displays the number of engines and fuel tanks on the vessel as well as fuel tank capacity. You selected your engine-tank configuration during Boat Setup. If the selected configuration is incorrect, you can return to Boat Setup by resetting the configuration from the Engine/Tank Configuration menu.

To reset Eng/Tank configuration:

1. Press **MENU**, use the **UP** and **DOWN** keys to highlight **SYSTEM SETUP** and press **ENTER**.
2. Select **ENG/TANK CFG** and press **ENTER**. The Engine Tank information screen appears with the following message at the bottom of the page: *Press Enter to reset Cfg* (configuration).

3. Press **ENTER** and the following message will appear: *Press Enter to reset Eng/Tank Cfg.*

4. Press **ENTER**, which will open the Boat Setup menu. Press **ENTER**, then use the **UP** and **DOWN** keys to select an engine-tank configuration that matches the number of engines and tanks on your vessel.

The Boat Setup menu options are: 1 Eng/1 Tank, 1 Eng/2 Tank, 2 Eng/1 Tank, 2 Eng/2 Tanks, 3 Eng/1 Tank or 3 Eng/3 Tanks.

5. Select the desired option and press **ENTER**, which will open the Tank Size menu. The Tank Size menu will have up to three options (Port Tank, Cen Tank, Stbd Tank), depending on the engine tank configuration you selected during Boat Setup. (If you selected one tank during Boat Setup, you will not see any of these options. You will be taken directly to the Setting Tank Size Window.)

6. Select a tank and press **ENTER** to open the Setting Tank Size window.

7. Use the **UP** and **DOWN** keys to enter how many gallons the tank will hold and press **ENTER**. Repeat steps 6 and 7 for each remaining tank.

NOTE:

If you have one tank, press **ENTER** after you have input the capacity of the tank. Press **EXIT** repeatedly to get back to the main display.

8. After all tanks have been setup, press **EXIT** repeatedly to return to the main display.

Reset Values:

The Reset command allows you to reset all values back to factory default settings.

To reset values:

1. Press **MENU**, use the **UP** and **DOWN** keys to select **SYSTEM SETUP** and press **ENTER**.

2. Select **RESET VALUES** and press **ENTER**. The following message will appear: *Press Enter to Reset All Values.*

3. Press **ENTER** to reset values. You will be taken back to the main display.

WARNING:

Resetting values is a hard reset. All LMF-400 settings will be set back to factory defaults. Resetting values, however, does not affect engine/tank configuration or the calibration and configuration settings of devices on the bus.

NMEA Info

The NMEA information screen displays information about your NMEA network, including address, instance, serial number and database version.

To access the NMEA Information screen:

1. Press **MENU**, use the **UP** and **DOWN** keys to select **SYSTEM SETUP** and press **ENTER**.
2. Highlight **NMEA INFO** and press **ENTER**. Press **EXIT** repeatedly to get back to the main display.

System Information

Access the system information screen to see what version of software you have in your LMF-400.

To access the System Information screen:

1. Press **MENU**, use the **UP** and **DOWN** keys to select **SYSTEM SETUP** and press **ENTER**.
2. Highlight **SYSTEM INFO** and press **ENTER**. Press **EXIT** repeatedly to get back to the main display.

Speed Range

The Speed Range function is included in the System Setup menus of the following pages: Synchronizer, Single Analog, Dual Analog and Quad Analog. The Speed Range feature can make on-screen gauges easier to read by allowing you to choose a range that will better fit your vessel's speed capabilities. If, for example, your vessel's speed range is 0-40, the unnecessary figures (41-120) will only crowd the gauge display, making it harder to read. Using the Speed Range feature allows you to eliminate unnecessary figures from the display, giving it better resolution. The default speed range is 0-40 mph.

To set Speed Range:

1. With the single analog, dual analog, quad analog or synchronizer page on the screen, press **MENU**, use the **UP** and **DOWN** keys to select **SYSTEM SETUP**, and press **ENTER**.
2. Highlight **SPEED RANGE** and press **ENTER**, which will open the Speed range menu.
3. The Speed Range menu will appear with three options: 0-40, 0-80 and 0-120.
4. Select the desired range and press **ENTER**, which will take you back to the main display.

Pressure Ranges

The Pressure Range screen is included in the System Setup menus of the following pages: Synchronizer, Single Analog, Dual Analog and

Quad Analog. Pressure Range can make on-screen gauges easier to read by allowing you to select a range that will better fit your vessel's pressure range. If, for example, your vessel's water pressure range is 0-30 PSI, the unnecessary figures (31-100 PSI) will only crowd the gauge display, making it harder to read. Using the Pressure Range feature allows you to eliminate unnecessary figures from the display, giving it better resolution.

To set Pressure Range:

1. With the single analog, dual analog, quad analog, synchronization page on the screen, press **MENU**, use the **UP** and **DOWN** keys to select **SYSTEM SETUP** and press **ENTER**.
2. Highlight **PRESS RANGES** (Pressure Ranges) and press **ENTER**, which will open the Pressure range menu with the following options: Eng Wtr Press (Engine Water Pressure), Eng Oil Press (Engine Oil Pressure), Fuel Pressure, Eng Bst Press (Engine Boost Pressure) and Trns Oil Press (Transmission Oil Pressure).
3. Select the desired pressure category and press **ENTER**. A menu will appear with these options: 0-15 PSI, 0-30 PSI, 0-60 PSI, 0-80 PSI, 0-100 PSI.
4. Highlight the desired pressure range and press **ENTER**. You will be taken back to the main display.

Change Units

The **CHANGE UNITS** feature allows you to change the units of measure for the following options: Speed/Distance, Temperature, Pressure, Depth, GPS Coordinates and Volume.

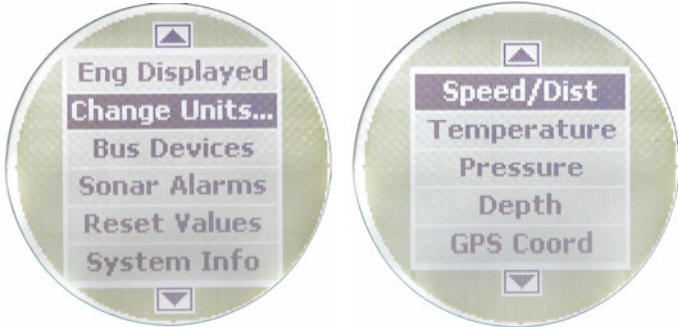

System Setup menu (left) with Change Units highlighted. The Change Units menu (right) with Speed/Distance selected.

To change Speed and Distance units:

Choosing Speed and Distance from the Change Units menu will allow you to set the unit of measure for speed and distance to Statute, Nautical or SI (Metric).

1. Press **MENU**, use the **UP** and **DOWN** keys to select **SYSTEM SETUP** and press **ENTER**.
2. Highlight **CHANGE UNITS** and press **ENTER**. Select **SPEED/DIST** and press **ENTER** to open the Speed and Distance menu.
3. Select the desired option — **STATUTE**, **NAUTICAL** or **SI (METRIC)** — and press **ENTER**. The unit of measure has been changed to the option you selected. You will be directed to the main display.

To change Temperature units:

Accessing Temperature from the Change Units menu will allow you to set the unit of measure for temperature to Fahrenheit or Celsius.

1. Press **MENU**, use the **UP** and **DOWN** keys to select **SYSTEM SETUP** and press **ENTER**. Highlight **CHANGE UNITS** and press **ENTER**.
2. Select **TEMPERATURE** and press **ENTER** to open the Temperature menu.
3. Highlight the desired option — **FAHRENHEIT** or **CELSIUS** — and press **ENTER**. The unit of measure has been changed to the option you selected. You will be directed to the main display.

To change Pressure units:

Selecting Pressure from the Change Units menu will allow you to set the unit of measure for pressure to Imperial/US or SI/Metric.

1. Press **MENU**, use the **UP** and **DOWN** keys to select **SYSTEM SETUP** and press **ENTER**.
2. Highlight **CHANGE UNITS** and press **ENTER**. Select **PRESSURE** and press **ENTER** to open the Pressure menu.
3. Choose the desired option — **IMPERIAL/US** or **SI/METRIC** — and press **ENTER**. The unit of measure has been changed to the option you selected. You will be directed to the main display.

To change Depth units:

Choosing Depth from the Change Units menu will allow you to set the unit of measure for depth to Feet, Fathoms or Meters.

1. Press **MENU**, use the **UP** and **DOWN** keys to select **SYSTEM SETUP** and press **ENTER**.
2. Highlight **CHANGE UNITS** and press **ENTER**. Select **DEPTH** and press **ENTER** to open the Depth menu.
3. Choose the desired option — **FEET**, **FATHOMS** or **METERS** — and press **ENTER**. The unit of measure has been changed to the option you selected. You will be directed to the main display.

To change GPS units:

Selecting GPS Coord from the Change Units menu will allow you to set the unit of measure for GPS coordinates to Deg/Min or Deg/Min/Sec.

1. Press **MENU**, use the **UP** and **DOWN** keys to select **SYSTEM SETUP** and press **ENTER**.

2. Highlight Change Units and press **ENTER**. Select **GPS COORD** and press **ENTER** to open the GPS Coordinates menu.
3. Select the desired option — **DEG/MIN** or **DEG/MIN/SEC** — and press **ENTER**. The unit of measure has been changed to the option you selected. You will be directed to the main display.

To change Volume units:

Choosing Volume from the Change Units menu will allow you to set the unit of measure for volume to US Gallons or Liters.

1. Press **MENU**, use the **UP** and **DOWN** keys to select **SYSTEM SETUP** and press **ENTER**.
2. Highlight **CHANGE UNITS** and press **ENTER**. Select **VOLUME** and press **ENTER** to open the Volume menu.
3. Select the desired option — **US GALLONS** or **LITERS** — and press **ENTER**. The unit of measure has been changed to the option you selected. You will be directed to the main display.

Fuel Setup

The following options may be accessed through the Fuel Setup menu: Refill Tank, Partial Fill, Economy Speed Source, Fuel Remaining Source, Reset Trip Fuel and Reset Seasonal Fuel.

Refill Tank

The Refill Tank command ensures the LMF-400 fuel reading is consistent with the actual amount of fuel in your tank(s). The Refill Tank command must be used with the EP-10 Fuel Flow, EP-50 Storage Device and the Suzuki NMEA 2000 Engine Interface. The Refill Tank command is NOT used when the EP-15 Fluid Level is used to read the fuel level.

To refill tank:

1. Press **MENU**, use the **UP** and **DOWN** keys to select **SYSTEM SETUP** and press **ENTER**.
2. Highlight **FUEL SETUP** and press **ENTER**.
3. Select **REFILL TANK** and press **ENTER**. The select Tank menu will appear with up to three options (Port, Center and Starboard), depending on the engine-tank configuration you chose during Boat Setup. Select the tank you refilled and press **ENTER**. (If you have one tank, you will be taken directly to the recalibration window mentioned in step 4.)

NOTE:

If an EP-10 Fuel Flow or a Suzuki NMEA 2000 Engine Interface is being used a menu will appear giving you the option to calibrate fuel calculations. We will discuss calibration in Section 4: Configuration and Calibration.

4. A recalibration window will appear with two options: Yes and No. Select **No** and press **ENTER**. The following message will appear: *Press Enter after refilling the fuel tank.*

NOTE:

You will only recalibrate when greater accuracy is necessary or when default settings appear to be wrong. We will discuss calibration in detail in Section 4: EP Configuration and Calibration.

5. Press **ENTER**. You will be directed back to the main display.

Partial Fill

The Partial Fill command is used when fuel is added to the tank, but the tank is not filled completely. Partial Fill must be used with the EP-10 Fuel Flow, EP-50 Storage Device and the Suzuki NMEA 2000 Engine Interface.

NOTE:

When using the Partial Fill command, you will only be able to input an fuel amount less or equal to the fuel used figure. The unit will not allow you to input a fuel amount greater than the fuel used figure.

To use Partial Fill:

1. Press **MENU**, use the **UP** and **DOWN** keys to select **SYSTEM SETUP** and press **ENTER**. Highlight **FUEL SETUP** and press **ENTER**.

2. Select **PARTIAL FILL** and press **ENTER**. The Select Tank menu will appear with up to three options (Port, Center and Starboard), depending on the engine-tank configuration you selected during Boat Setup. (If you have one tank, you will be taken directly to the Adding Fuel window.)

3. Select the desired tank and press **ENTER**. The Adding Fuel window will appear.

NOTE:

When using the Partial Fill command, you will only be able to input into the gauge, an amount of fuel less or equal to the fuel used figure. The unit will not allow you to enter a fuel amount greater than the fuel used figure.

4. Use the **UP** and **DOWN** keys to input the amount of fuel added to the tank and press **ENTER**. You will be taken back to the main display.

Economy Speed Source

The Economy Speed menu allows you to choose what speed source the LMF-400 will use to calculate Fuel Economy. A NMEA 2000 GPS module, like the LGC-2000, measures ground speed The EP-25 Paddlewheel and NMEA 2000 Pitot tube measure water speed.

NOTE:

Ground Speed is the default speed source for Fuel Economy.

To change Economy Speed source:

1. Press **MENU**, use the **UP** and **DOWN** keys to select **SYSTEM SETUP** and press **ENTER**. Select **FUEL SETUP** and press **ENTER**.
2. Highlight **ECO SPEED SRC** and press **ENTER** to open the Economy Speed menu. The menu has three options: Water Speed (Paddlewheel), Pitot Speed and Ground Speed (GPS).
3. Select the desired speed source and press **ENTER**. You will be taken back to the main display.

Fuel Remaining Source

The Fuel Remaining source function allows you to select the device used to measure the amount the fuel remaining in the tank.

NOTE:

If you plan to use a fluid level sensor for a fuel tank, you must switch the fuel remaining source to Fuel Level. If you want to use the EP-10 Fuel Flow, EP-50 Storage Device or the NMEA 2000 Suzuki Engine Interface to measure fuel remaining, select Engine/FFlow from the Fuel Remaining Source menu.

To change Fuel Remaining Source:

1. Press **MENU**, use the **UP** and **DOWN** keys to select **SYSTEM SETUP** and press **ENTER**.
2. Highlight **FUEL SETUP** and press **ENTER**.
3. Select **FUEL REM SRC** (Fuel Remaining Source) and press **ENTER**.
4. Highlight the device you want to use to measure remaining fuel — **ENG/FFLOW** (Engine Fuel Flow) or **FLUID LEV SNSR** (Fluid Level Sensor) — and press **ENTER**. You will be taken back to the main display.

Reset Trip Fuel

A few sensors, like the Suzuki Engine Interface, EP-10 Fuel Flow and EP-50 Storage Device keep a running total of fuel used for a trip. By using the Reset Trip command, you can reset to zero the running total of fuel used on a trip.

To reset trip fuel:

1. Press **MENU**, use the **UP** and **DOWN** keys to select **SYSTEM SETUP** and press **ENTER**. Select **FUEL SETUP** and press **ENTER**.
2. Highlight **RST TRIP FUEL** and press **ENTER**. The Select Engine menu will appear with up to four options (Port, Center, Starboard and All Engines), depending on the engine-tank configuration you selected during Boat Setup. (If you have one tank, the *Press Enter to reset Trip Fuel* message will appear.)

3. Select the desired option and press **ENTER**. The following message will appear: *Press Enter to reset Trip Fuel*.

4. Press **ENTER**, which will reset the trip fuel and take you back to the main display.

Reset Seasonal

A few sensors, like the Suzuki Engine Interface, EP-10 Fuel Flow and EP-50 Storage Device keep a running total of fuel used for a season. By using the Reset Seasonal command, you can reset to zero the running total of fuel used for a season.

To reset seasonal fuel:

1. Press **MENU**, use the **UP** and **DOWN** keys to select **SYSTEM SETUP** and press **ENTER**.

2. Highlight **FUEL SETUP** and press **ENTER**.

3. Select **Rst SEASONAL** (Reset Seasonal) and press **ENTER**. The Select Engine menu will appear with up to four options (Port, Center, Starboard and All Engines), depending on the engine-tank configuration you chose during Boat Setup. (If you have one engine, the reset seasonal fuel message will appear.)

4. Select the desired option and press **ENTER**. The following message will appear: *Press Enter to reset Seasonal Fuel*.

5. Press **ENTER** to reset seasonal fuel. You will be taken back to the main display.

Customizing Pages

The customizing pages feature allows you to choose what data will be displayed on selected pages. Pages that can be customized include: Single Analog, Dual Analog, Quad Analog, Single Digital, Dual Digital, Quad Digital, Fuel Manager and Trim Tab pages. The Engine Trim, Engine Diagnostic, GPS Position and Synchronizer pages cannot be customized.

NOTE:

Before a page can be customized it must be added to the page screen rotation. (See the Adding Pages segment on page 13.) Once it is in the rotation, scroll it onto the main display to access its customize menu.



Basic menu with Customize highlighted.

Single Analog

The Single Analog page may be customized to display these data types: Alt Voltage, Battery Voltage, Engine Temp, Engine Water Pressure, Engine Oil Pressure, Fuel Pressure, Engine Boost Pressure, Transmission Oil Pressure, Atmospheric Pressure, Temperature, Fluid Level, Water Speed (Paddlewheel), Ground Speed (GPS), and Tachometer.

To customize Single Analog page:

1. Make sure the Single Analog page has been added to the page screen rotation.
2. Use the **ENTER** and **EXIT** keys to scroll the Single Analog page onto the main display.
3. Press **MENU**, use the **UP** and **DOWN** keys to select **CUSTOMIZE** and press **ENTER**. The data menu will appear.
4. Select the data type you want to display and press **ENTER**. You will be taken back to the main display where the Single Analog page will be shown with the data you selected.

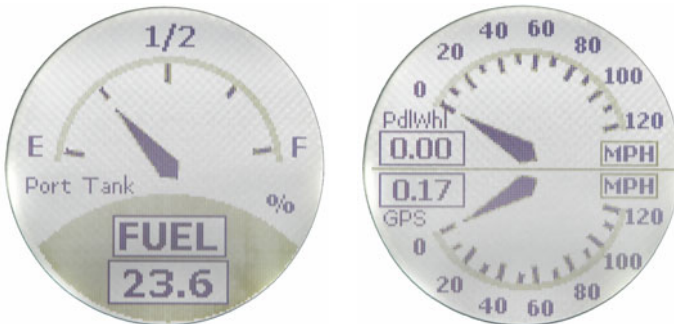

Single Analog page (left) with Dual Analog page (right).

Dual Analog

The Dual Analog page consists of two analog gauges and may be customized to show these data types: Alt Voltage, Battery Voltage, Engine Temp, Engine Water Pressure, Engine Oil Pressure, Fuel Pressure, Engine Boost Pressure, Transmission Oil Pressure, Atmospheric Pressure, Temperature, Fluid Level, Water Speed (Paddlewheel), Ground Speed (GPS), and Tachometer.

To customize Dual Analog page:

1. Make sure the Dual Analog page has been added to the page screen rotation.
2. Use the **ENTER** and **EXIT** keys to scroll the Dual Analog page onto the main display.
3. Press **MENU**, use the **UP** and **DOWN** keys to select **CUSTOMIZE** and press **ENTER**. A menu will appear with two options: Top Gauge and Bottom Gauge.
4. Select the desired gauge and press **ENTER**. The data menu will appear.
5. Highlight the data category you want to display and press **ENTER**. Repeat steps 1-5 for the other half of the page (Top Gauge or Bottom Gauge).
6. Press **EXIT** | **EXIT** to return to the main display where the Dual Analog page will be shown with the data types you selected.

Quad Analog

The Quad Analog page is divided into four analog gauges, each capable of displaying these data types: Alternator Voltage, Battery Voltage, Engine Temperature, Engine Water Pressure, Engine Oil Pressure, Fuel Pressure, Engine Boost Pressure, Transmission Oil Pressure, Atmospheric Pressure, Temperature, Fluid Level, Water Speed (Paddlewheel), Ground Speed (GPS) and Tachometer.

To customize Quad Analog page:

1. Make sure the Quad Analog page has been added to the page screen rotation.
2. Use the **ENTER** and **EXIT** keys to scroll the Quad Analog page onto the main display.
3. Press **MENU**, select **CUSTOMIZE** and press **ENTER**. A menu will appear with four options: Top Left, Top Right, Bottom Left and Bottom Right.
4. Select the desired option and press **ENTER**. The data menu will appear.
5. Highlight the data you want to display and press **ENTER**. Repeat steps 1-5 for each gauge (Top Left, Top Right, Bottom Left and Bottom Right).

6. Press **EXIT** | **EXIT** to get back to the Quad Analog page, where the data you selected will be displayed.

NOTE:

If a page is customized to show information from a device that is working improperly or is not connected to the NMEA 2000 network, the data boxes on the gauge will flash. This indicates the device is not sending data to the network. This could occur for a variety of reasons, depending on the device type.

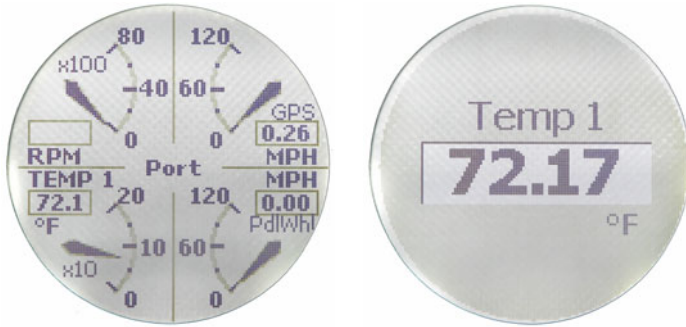

Quad Analog page (left) with Single Digital page (right).

Single Digital

The single digital page can display these data types: Alternator Voltage, Battery Voltage, Engine Temperature, Engine Water Pressure, Engine Oil Pressure, Fuel Pressure, Engine Boost Pressure, Transmission Oil Pressure, Atmospheric Pressure, Temperature, Depth, Engine Load, Total Engine Hours, Fuel Flow, Fuel Economy, Fuel Remaining, Fuel Used, Fuel Range, Trip Fuel Use, Seasonal Fuel, Water Speed (Paddle Wheel Speed), Ground Speed (GPS) and Tachometer.

To customize Single Digital page:

1. Make sure the Single Digital page has been added to the page screen rotation.
2. Use the **ENTER** and **EXIT** keys to scroll the Single Digital page onto the main display.
3. Press **MENU**, select **CUSTOMIZE** and press **ENTER**. The data menu will appear.
4. Highlight the data you want to display and press **ENTER**. You will be taken back to the main display where the single digital page will be displayed with the data you selected.

Dual Digital

The Dual Digital page has two digital data boxes stacked one on top of the other. The digital data boxes can display: Alternator Voltage,

Battery Voltage, Engine Temperature, Engine Water Pressure, Engine Oil Pressure, Fuel Pressure, Engine Boost Pressure, Transmission Oil Pressure, Atmospheric Pressure, Temperature, Depth, Engine Load, Total Engine Hours, Fuel Flow, Fuel Economy, Fuel Remaining, Fuel Used, Fuel Range, Trip Fuel Use, Seasonal Fuel, Water Speed (Paddle Wheel Speed), Ground Speed (GPS) and Tachometer.

To customize the Dual Digital page:

1. Make sure the Dual Digital page has been added to the page screen rotation.
2. Use the **ENTER** and **EXIT** keys to scroll the Dual Digital page onto the main display.
3. Press **MENU**, select **CUSTOMIZE** and press **ENTER**. A menu will appear with two options: Top Data and Bottom Data.
4. Highlight the desired option and press **ENTER**. The data menu will appear.
5. Select the data you want to display and press **ENTER**. One of two things will happen, depending on the data category you selected.
 1. If you chose Atmospheric Pressure, Temperature, Depth, Water Speed or Ground Speed, you will be taken back to the Top Data-Bottom Data menu. Repeat Steps 4-5 for the other data box.
 2. If you selected Alternator Voltage, Battery Voltage, Engine Temp, Engine Water Pressure, Engine Oil Pressure, Fuel Pressure, Engine Boost Pressure, Transmission Oil Pressure, Engine Load, Total Engine Hours, Fuel Flow, Fuel Economy, Fuel Remaining, Fuel Used, Fuel Range, Trip Fuel Used, Seasonal Fuel or Tachometer, you will be taken to the Select Engine menu where there will be up to three options: Port, Center and Starboard. The data category you selected will retrieve data from the engine you choose. Select the desired engine and press **ENTER**. You will be taken back to the Top Data-Bottom Data menu. Highlight the other data box and repeat steps 4-5.
6. When both digital data boxes are customized, press **EXIT|EXIT** to return to the main display, where the dual digital page will be shown with the data you chose.

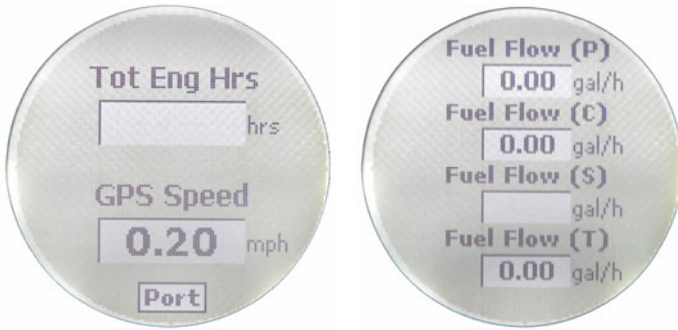

Dual Digital page (left) with Quad Digital page (right).

Quad Digital

The Quad Digital page has four digital data boxes, stacked one on top of the other. The digital data boxes can display: Alternator Voltage, Battery Voltage, Engine Temperature, Engine Water Pressure, Engine Oil Pressure, Fuel Pressure, Engine Boost Pressure, Transmission Oil Pressure, Atmospheric Pressure, Temperature, Depth, Engine Load, Total Engine Hours, Fuel Flow, Fuel Economy, Fuel Remaining, Fuel Used, Fuel Range, Trip Fuel Use, Seasonal Fuel, Water Speed (Paddle Wheel Speed), Ground Speed (GPS) and Tachometer.

To customize Quad Digital page:

1. Make sure the Quad Digital page has been added to the page display.
2. Use the **ENTER** and **EXIT** keys to scroll the Quad Digital page onto the main display.
3. Press **MENU**, select **CUSTOMIZE** and press **ENTER**. The Data Box menu will appear with four options: Data Box 1, Data Box 2, Data Box 3 and Data Box 4.
4. Highlight the desired data box and press **ENTER**. A list of data types will appear.
5. Select the data you want to display and press **ENTER**. One of two things will happen, depending on the data category you selected.
 1. If you chose Atmospheric Pressure, Temperature, Depth, Water Speed or Ground Speed, you will be taken back to the Data Box menu. Repeat Steps 4-5 for the other digital data boxes.
 2. If you selected Alternator Voltage, Battery Voltage, Engine Temp, Engine Water Pressure, Engine Oil Pressure, Fuel Pressure, Engine Boost Pressure, Transmission Oil Pressure, Engine Load, Total Engine Hours, Fuel Flow, Fuel Economy, Fuel Remaining, Fuel Used, Fuel Range, Trip Fuel Used, Seasonal Fuel or Tachometer, you will be taken to the Select Engine menu which will have up to

three options: Port, Center and Starboard. The data you selected will originate from the engine you choose. Select the desired engine and press **ENTER**. You will be taken back to the Data Box menu. Highlight the other digital data boxes and repeat steps 4-5.

6. When all Data boxes have been customized, press **EXIT|EXIT** to return to the main display, where the Quad Digital page will be shown with the data you selected.

Trim Tabs

The Trim Tab page can display Trim Tabs position in percentages and degrees.

Customize Trim Tabs:

1. Make sure the Trim Tabs page has been added to the page screen rotation.
2. Use the **ENTER** and **EXIT** keys to scroll the Trim Tabs page onto the main display.
3. Press **MENU**, select **CUSTOMIZE** and press **ENTER**. The Trim Tabs Customize menu will appear with two options: Percentage or Degrees.
4. Select the desired option and press **ENTER**. You will be taken back to the main display, where trim tab information will be displayed in the unit of measure you chose.



Trim Tabs page (left), GPS Module page (center) and Fuel Manager Page (right).

Fuel Manager

The Fuel Manager page has three digital data boxes stacked one on top of the other. Each digital data box can display these data types: Fuel Flow, Fuel Economy, Fuel Remaining, Fuel Used, Fuel Range, Trip Fuel Used, Seasonal Fuel, Water Speed (Paddle Wheel Speed) and Ground Speed (GPS).

To customize the Fuel Manager Page:

1. Make sure the Fuel Manager page has been added to the page screen rotation.
2. Use the **ENTER** and **EXIT** keys to scroll the Fuel Manager page onto the main display.

3. Press **MENU**, select **CUSTOMIZE** and press **ENTER**. The data location menu will appear with three options: Top Data, Center Data and Bottom Data.
4. Highlight the desired data location and press **ENTER**. A list of data types will appear.
5. Select the desired data category and press **ENTER**. One of two things will happen, depending on the data category you selected.
 1. If you chose Water Speed or Ground Speed, you will be taken back to the Data Location menu. Repeat Steps 4-5 for the other data locations you want to customize.
 2. If you chose Fuel Flow, Fuel Economy, Fuel Remaining, Fuel Used, Fuel Range, Trip Fuel Used or Seasonal Fuel, you will be taken to the Select Engine menu which will have up to three options: Port, Center and Starboard. Select the engine you would like to use as the source for the data category you selected and press **ENTER**. You will be taken back to the Data Location menu.
6. Repeat Steps 4 and 5 for each of the other data locations you want to customize. When all have been customized, press **EXIT | EXIT** to get back to the Fuel Manager page.

Section 4: EP Configuration & Calibration

To configure items connected to the LowranceNET, press **MENU**, select **SYSTEM SETUP** and press **ENTER**. Highlight **BUS DEVICES** and press **ENTER** to open the Bus Devices list. Bus Devices works as the device manager for the bus, allowing you to configure and unconfigure devices and set and reset critical values such as alarms and calibration.

NOTE:

The Suzuki Engine Interface, EP-35 Temperature sensor, EP-15 Fluid Level, EP-50 Storage Device and EP-10 Fuel Flow are the only sensors that can be configured through the Bus Devices list.



Bus Devices highlighted in the System Setup menu (left). Searching Bus Devices window (center) with Bus Devices list (right).

EP-35 Temperature Configuration

The EP-35 Temperature sensor has three configuration options: Inside, Outside and Water. An unconfigured temperature sensor will appear on the bus devices list as UnCfg Temp.

To configure EP-35 Temp Sensor:

1. Press **MENU**, use the **UP** and **DOWN** keys to select **SYSTEM SETUP** and press **ENTER**.
2. Highlight **BUS DEVICES** and press **ENTER**. The Bus Devices list will appear.
3. Select an unconfigured temp sensor (**UNCFG TEMP**) and press **ENTER**. The following message will appear: *Press Enter to Configure Temp Sensor*.
4. Press **ENTER**, which will open the Sel Temp menu with three options: Water Temp, Outside Temp and Inside Temp.
5. Highlight the desired option and press **ENTER**. The temp is now configured. You will be directed to the Bus Devices list. Press **EXIT** repeatedly to get back to the main display.

To unconfigure an EP-35 temp sensor:

1. Press **MENU**, use the **UP** and **DOWN** keys to select **SYSTEM SETUP** and press **ENTER**.
2. Highlight **BUS DEVICES** and press **ENTER**. The Bus Devices list will appear, showing all devices detected on the network.
3. Choose the temp sensor you want to unconfigure and press **ENTER**. Select **UNCONFIGURE** from the temp configuration menu and press **ENTER**. The following message will appear: *Press Menu to UnConfig Device Name*.
4. Press **ENTER** to unconfigure the sensor and be directed back to the Bus Devices list where the temp now will be listed as UnCfg Temp.

To reconfigure an EP-35 temp sensor:

To reconfigure a sensor, there must be a configuration name available (Water, Outside or Inside). If all three temp sensors have been configured, you first will have to unconfigure a temp sensor to make its name available for reconfiguration. If you try to reconfigure a sensor when the desired configuration name (Water, Outside and Inside) is in use, a *Name Already Selected* message will appear.

If all three temps are configured, which means there is no name configuration available, follow the first set of instructions. If the desired configuration name is available, follow the second set of instructions.

The steps below will show you how to switch the configuration of a water temp to an outside temp.

If all temps configured (Configuration name unavailable):

1. Press **MENU**, use the **UP** and **DOWN** keys to select **SYSTEM SETUP** and press **ENTER**.
2. Highlight **BUS DEVICES** and press **ENTER**. Select **OUT: T** (Outside Temp) and press **ENTER** to open the temp configuration menu.
3. Select **UNCONFIGURE** and press **ENTER**. The following message will pop up: *Press Enter to UnConfig Device Name*.
4. Press **ENTER** to unconfigure the sensor and be taken back to the Bus Devices list. The Outside temp is now unconfigured and will be displayed as UnCfg Temp. Its configuration name (Outside) is now available, so you will be able to use it to reconfigure the Water temp sensor.
5. Highlight **WTR: T** and press **ENTER**, which will open the temp configuration menu. Select **RECONFIGURE** and press **ENTER**. That will direct you to the Temp Selection menu, which will have three options: Water, Outside and Inside.

6. Select **OUTSIDE** and press **ENTER**. You will be taken back to the Bus Devices list. The temp you just reconfigured (formerly water temp) will now be displayed as Out: T.

7. To configure the unconfigured Temp (formerly Outside temp), highlight **UNCFG TEMP** from the Bus Devices list and press **ENTER** to open the Temp Selection menu, which will have three options: Water, Outside and Inside. Highlight **WATER** and press **ENTER**. You will be taken back to the Bus Devices list, where the temp you just configured will be displayed as WTR: T.

If desired configuration name available:

1. Press **MENU**, use the **UP** and **DOWN** keys to select **SYSTEM SETUP** and press **ENTER**.

2. Highlight **BUS DEVICES** and press **ENTER**. Select **WTR: T** and press **ENTER** to open the configuration options menu.

3. Select **RECONFIGURE** and press **ENTER** to open the Temp Selection menu, which will have three options: Water, Outside and Inside.

4. Highlight **OUTSIDE** and press **ENTER**. You will be taken back to the Bus Devices list where the temp will now be shown as Out T.

EP-10 Fuel Flow Configuration

You can have up to three fuel flow sensors installed on your vessel, one for each engine supported by the LMF-400. The number of fuel flows listed on the Bus Devices list depends on the engine-tank configuration you chose during Boat Setup. A three-engine configuration will display fuel flows as Port Fuel Flow (Port FFlow), Center Fuel Flow (Cen FFlow) and Starboard Fuel Flow (Stbd FFlow). When accessing a fuel flow, its menu will appear with the following options: Change Engine (for two or more engines only), Fuel Warning, Unset Engine, Reset Values and Reset Calibration.

After a fuel flow has been added to the network, you are ready to proceed with its configuration.

NOTE:

If, after configuring, unconfiguring or reconfiguring a fuel flow, it is not shown on the Bus Devices list, you will have to refresh the list. Press **MENU**, select **SYSTEM SETUP** and press **MENU**. Highlight **BUS DEVICES** and press **MENU**. The Fuel Flow will be listed with its new configuration setting.

To configure an EP-10 Fuel Flow:

When you configure a fuel flow, you are linking the fuel flow's location/engine on the boat to its matching configuration/device name (Port, Center or Starboard) in the LMF-400.

1. Press **MENU**, use the **UP** and **DOWN** keys to select **SYSTEM SETUP** and press **ENTER**.
2. Highlight **BUS DEVICES** and press **ENTER**. The Bus Devices list will appear.
3. Select **UNCFG F FLOW** and press **ENTER**. The following message will appear: *Press Enter to Configure Fuel Flow Snsr.*
4. Press **ENTER** to open the Select Engine menu with up to three engine options: Port, Center and Starboard.

NOTE:

If your unit is set to a one-engine configuration, the Configuration Options menu will not appear when you are configuring a fuel flow. On the Bus Devices list, the fuel flow will automatically be given the configuration name Eng FFlow.

5. Select the desired engine and press **ENTER**. You will be taken back to the Bus Devices list where the fuel flow will now be listed as Port FFlow, Cen FFlow or Stbd FFlow, depending on the engine you chose from the Select Engine menu. Press **EXIT** repeatedly to get back to the main display.

To unconfigure an EP-10 Fuel Flow:

The unconfigure command allows you to set an EP-10 fuel flow back to its original unconfigured status.

Unset Engine

1. Press **MENU**, use the **UP** and **DOWN** keys to select **SYSTEM SETUP** and press **ENTER**.
2. Highlight **BUS DEVICES** and press **ENTER** to open the Bus Devices list.
3. Select the desired fuel flow and press **ENTER**. The Fuel Flow menu will appear. Select **UNSET ENGINE** and press **ENTER**. The following message will appear: *Press Enter to UnConfig Device Name.*
4. Press **ENTER** and you will be directed back to the Bus Devices list, where the fuel flow you unconfigured will be shown as UnCfg F Flow.

To reconfigure an EP-10 Fuel Flow:

You will use the Change Engine command to reconfigure a Fuel Flow. Change Engine, however, will only appear on your LMF-400 menu if you have more than one engine. If all the fuel flows on your vessel are configured, you will have to unconfigure a fuel flow to free up its configuration name (Port, Center, Starboard).

If all three fuel flows are configured, which means there is no name configuration available, follow the first set of instructions. If the desired configuration name is available, follow the second set of instructions.

Change Engine (active only with multiple-engine setting)

The steps below show how to switch the configuration name of a fuel flow from the port engine to the starboard engine.

If all fuel flows configured (Configuration name unavailable):

1. Press **MENU**, use the **UP** and **DOWN** keys to select **SYSTEM SETUP** and press **ENTER**.
2. Highlight **BUS DEVICES** and press **ENTER**. The Bus Devices list will appear.
3. Select the Port fuel flow and press **ENTER**. Highlight **UNSET ENGINE** and press **ENTER**. The following message will appear: *Press Enter to UnCfg Device Name*.
4. Press **ENTER**. You will be taken back to the Bus Devices list, where the port fuel flow will now be displayed as UnCfg FFlow.
5. Select the Starboard Fuel Flow and press **ENTER**.
6. Highlight **CHANGE ENGINE** and press **ENTER**. The Select Engine menu will appear with up to three options (Port, Center and Starboard), depending on your engine-tank configuration.
7. Select **PORT** and press **ENTER**. You will be taken back to the Bus Devices list.
8. Highlight UnCfg FFlow and press **ENTER**. The following message will appear: *Press Enter to Configure Fuel Flow Sns*.
9. Press **ENTER**, which will open the Select Engine menu. Choose Starboard and press **ENTER**. You will be taken back to the Bus Devices list where the fuel flows will be shown with their new configuration names.

If desired configuration name available:

1. Press **MENU**, use the **UP** and **DOWN** keys to select **SYSTEM SETUP** and press **ENTER**.
2. Highlight **BUS DEVICES** and press **ENTER**. The Bus Devices list will appear.
3. Select the fuel flow you want to reconfigure and press **ENTER**. Highlight **CHANGE ENGINE** and press **ENTER**. The Select Engine menu will appear with up to three options (Port, Center or Starboard), depending on your engine-tank configuration.
4. Choose the desired configuration name and press **ENTER**. You will be taken back to the Bus Devices list, where the fuel flow you reconfigured will be displayed with its new configuration name.

Fuel Wrng (Fuel Warning)

Fuel Warning allows you to set a Low level or High level alarm for each fuel flow on the network. A pop-up window will appear if your fuel rises above or falls below a threshold of your choosing.

1. Press **MENU**, use the **UP** and **DOWN** keys to select **SYSTEM SETUP** and press **ENTER**.
2. Highlight **BUS DEVICES** and press **ENTER** to open the Bus Devices list.
3. Select the desired fuel flow and press **ENTER**, which will open the Fuel Flow menu.
4. Highlight **FUEL WRNG** and press **ENTER**. The Select Level menu will appear with two options: Low Level and High Level. Typically, a Fuel Level warning is used to alert you when your vessel is running low on fuel, so highlight **LOW LEVEL** and press **ENTER**. The Set Level Percentage window will appear, allowing you to set the level warning to the desired percentage of tank capacity. It will be set to **OFF** by default. (To turn off a level warning select Off.)
5. Use the **UP** and **DOWN** keys to set the desired fuel warning percentage and press **ENTER**. You will be taken back to the Bus Devices list.

Reset Values:

By accessing the Reset Values command from the Fuel Flow menu, you will be able to reset configuration and calibration settings for a particular fuel flow.

1. Press **MENU**, use the **UP** and **DOWN** keys to select **SYSTEM SETUP** and press **ENTER**.
2. Highlight **BUS DEVICES** and press **ENTER**. Select the fuel flow you want to reset and press **ENTER**.
3. Choose **RESET VALUES** from the fuel flow menu and press **ENTER**. The following message will appear: *Press Enter to Reset Device Values.*
4. Press **ENTER** and you will be taken back to the Bus Devices list, where the fuel flow will now be displayed as UnCfg F Flow.

NOTE:

By resetting values from the configuration menu, **ONLY** the device selected from the Bus Devices list will be set back to its defaults. When you Reset Values, the calibration and configuration settings of the device are set back to factory defaults.

EP-15 Fluid Level Configuration

The LMF-400 will support up to three tanks for each Fluid Level type which includes: Fuel, Fresh Water, Oil, Black Water, Waste Water (Gray Water) and Live Well.

On the Bus Devices list, the fuel tanks will be displayed as Fuel Tank (P) — Port Fuel Tank (C) — Center, and Fuel Tank (S) — Starboard. If you chose a one-tank configuration in Boat Setup, the tank will be listed as Fuel Tank.

Like a fuel tank, the Oil Tank will also be listed by its engine location — Oil Tank (P), Oil Tank (C) or Oil Tank (S).

When setting fluid level configuration for the other fluid types you will be given the opportunity to assign the tank a number in case you have more than one tank of that fluid type. The tanks will be listed with a tank number of your choosing. By default, the tank number is set to 1.

The other fluid types will be displayed as BlkWtr Tnk (1, 2 or 3), FrshWtr Tnk (1, 2 or 3), LWell Tnk (1, 2 or 3) and WsteWtr Tnk (1, 2 or 3). If the EP-15 fluid level has not been configured, it will be listed as Unfcg F Lev on the bus devices list.

NOTE:

The Fuel Remaining Source must be set to fluid level for the unit to correctly display fuel level information. It is set to Engine/Fuel Flow by default.

Fluid Level menu

The Fluid Level menu contains the following features: Configure, Unconfigure, Reconfigure, Level Warning, Calibrate, Reset Calibration and Reset Values. Calibration and Reset Calibration will be addressed in the calibration portion of this section.

Caution

If you configure your fluid level for fuel, you will NOT be able to get a fuel range reading. Fuel Range will NOT be calculated with a fluid level sensor. It will only be calculated with an engine interface, EP-10 Fuel Flow or EP-50 Storage Device.

To configure EP-15 Fluid Level for Fuel:

1. Make sure the Fuel Remaining Source has been set to Fluid Level. Press **MENU**, use the **UP** and **DOWN** keys to select **SYSTEM SETUP** and press **ENTER**.
2. Highlight **BUS DEVICES** and press **ENTER** to bring up the Bus Devices list.
3. Select **UNFCG F LEV** and press **ENTER**. The following message will appear: *Press Enter to configure Fluid Lev Snsr*.
4. Press **ENTER** and the Fluid Level configuration menu will appear.
5. Choose **FUEL** and press **ENTER**, which will open the Select Tank menu with up to three options: Port Tank, Center Tank and Starboard Tank. The number of tank options depends on the engine-tank configuration you chose during Boat Setup.
6. Select the tank connected to the fluid level you are configuring and press **ENTER**. You will be taken back to the Bus Devices list, where the tank will be displayed as Fuel Tank (P), Fuel Tank (C) or Fuel Tank (S). Press **EXIT** repeatedly to return to the main display.

To configure EP-15 for Fresh Water:

1. Press **MENU**, use the **UP** and **DOWN** keys to select **SYSTEM SETUP** and press **ENTER**.
2. Highlight **BUS DEVICES** and press **ENTER**. The Bus Devices list will appear.
3. Select **UNFCG F LEV** and press **ENTER**. The following message will appear: *Press Enter to configure Fluid Lev Snsr*. Press **ENTER** and the Fluid Level configuration menu will appear.
4. Choose **FRESH WATER** and press **ENTER**. The Tank Number window will appear.
5. Use the **UP** and **DOWN** keys to input the number you want to assign the tank and press **ENTER**. The Setting Tank Size window will appear on the screen.
6. Use the **UP** and **DOWN** keys to input the size of the tank and press **ENTER**. You will be taken back to the Bus Devices list, where the tank will be displayed as FrshWtr Tnk (1, 2 or 3).

To configure EP-15 for Waste Water (Gray Water):

1. Press **MENU**, use the **UP** and **DOWN** keys to select **SYSTEM SETUP** and press **ENTER**.
2. Highlight **BUS DEVICES** and press **ENTER**. The Bus Devices list will appear.
3. Select **UNFCG F LEV** and press **ENTER**. The following message will appear: *Press Enter to configure Fluid Lev Snsr*. Press **ENTER** and the Fluid Level configuration menu will appear.
4. Choose **WASTE WATER** and press **ENTER**. The Tank Number window will appear.
5. Use the **UP** and **DOWN** keys to input the number you want to assign the tank and press **ENTER**. The Setting Tank Size window will appear on the screen.
6. Use the **UP** and **DOWN** keys to input the size of the tank and press **ENTER**. You will be taken back to the Bus Devices list, where the tank will be displayed as WstWtr Tnk (1, 2 or 3). Press **EXIT** repeatedly to get back to the main display.

To configure EP-15 for Live Well:

1. Press **MENU**, use the **UP** and **DOWN** keys to select **SYSTEM SETUP** and press **ENTER**.
2. Highlight **BUS DEVICES** and press **ENTER**. The Bus Devices list will appear.

3. Select **UNFCG F LEV** and press **ENTER**. The following message will appear: *Press Enter to configure Fluid Lev Snsr*. Press **ENTER** and the Fluid Level configuration menu will appear.
4. Choose **LIVE WELL** and press **ENTER**. The Tank Number window will appear.
5. Use the **UP** and **DOWN** keys to input the number you want to assign the tank and press **ENTER**. The Setting Tank Size window will appear on the screen.
6. Use the **UP** and **DOWN** keys to input the size of the tank and press **ENTER**. You will be taken back to the Bus Devices list, where the tank will be displayed as LWell Tnk (1, 2 or 3).

To configure EP-15 for Oil:

1. Press **MENU**, use the **UP** and **DOWN** keys to select **SYSTEM SETUP** and press **ENTER**.
2. Highlight **BUS DEVICES** and press **ENTER**. The Bus Devices list will appear.
3. Select **UNFCG F LEV** and press **ENTER**. The following message will appear: *Press Enter to configure Fluid Lev Snsr*.
4. Press **ENTER** and the Fluid Level configuration menu will appear.
5. Choose **OIL** and press **ENTER**, which will open the Select Tank menu with up to three options: Port Tank, Cen Tank and Stbd Tank. The number of tank options depends on the number of tanks you chose during Boat Setup.
6. Select the desired tank and press **ENTER**.
7. The Tank Size window will appear. Use the **UP** and **DOWN** keys to input the size of the tank and press **ENTER**. You will be taken back to the Bus Devices list, where the tank will be displayed as Oil Tank (P), Oil Tank (C) or Oil Tank (S).

To configure EP-15 for Black Water:

1. Press **MENU**, use the **UP** and **DOWN** keys to select **SYSTEM SETUP** and press **ENTER**.
2. Highlight **BUS DEVICES** and press **ENTER**. The Bus Devices list will appear.
3. Select **UNFCG F LEV** and press **ENTER**. The following message will appear: *Press Enter to configure Fluid Lev Snsr*. Press **ENTER** and the Fluid Level configuration menu will appear.
4. Choose **BLACK WATER** and press **ENTER**. The Tank Number window will appear.

5. Use the **UP** and **DOWN** keys to input the number you want to assign to the tank and press **ENTER**. The Setting Tank Size window will appear on the screen.

6. Use the **UP** and **DOWN** keys to input the size of the tank and press **ENTER**. You will be taken back to the Bus Devices list, where the tank will be displayed as BlkWtr Tnk (1, 2 or 3).

To unconfigure Fluid Level:

1. Press **MENU**, use the **UP** and **DOWN** keys to select **SYSTEM SETUP** and press **ENTER**.

2. Highlight **BUS DEVICES** and press **ENTER**, which will open the Bus Devices list.

3. Choose a configured Fluid Level from the Bus Devices list and press **ENTER**. The Fluid Level will appear with the following options: Level Warning, Unconfigure, Reconfigure, Calibrate, Reset Cal and Reset Values.

3. Highlight **UNCONFIGURE** and press **ENTER**, which will launch the following message: *Press Enter to Unconfig Device name.*

4. Press **ENTER** and you will be taken back to the Bus Devices list where the fluid level you unconfigured will be displayed as UnCfg F Level.

To reconfigure Fluid Level:

1. Press **MENU**, use the **UP** and **DOWN** keys to select **SYSTEM SETUP** and press **ENTER**.

2. Highlight **BUS DEVICES** and press **ENTER**. The Bus Devices list will appear.

3. Select the Fluid Level you want to configure and press **ENTER**.

4. The Fluid Level menu will appear with the following options: Level Warning, Unconfigure, Reconfigure, Calibrate, Reset Cal and Reset Values.

5. Choose **RECONFIGURE** and press **ENTER**. Use the **UP** and **DOWN** keys to input the tank number you want to assign the fluid level and press **ENTER**. The Setting Tank Size window will appear on the screen.

6. Use the **UP** and **DOWN** keys to input the size of the tank and press **ENTER**. You will be taken back to the Bus Devices list, where the fluid level will be displayed with its new configuration.

Level Warning

A Level Warning alerts you when the fluid level rises above or falls below a preset percentage of tank capacity. The Level Warning menu has two options: Low Level and High Level. A low level warning is used for fluid types like fuel, oil and freshwater, whereas a high level warning is best suited for black water and Waste Water (Gray Water).

To set a Level Warning:

1. Press **MENU**, use the **UP** and **DOWN** keys to **SYSTEM SETUP** and press **MENU**.
2. Highlight **BUS DEVICES** and press **ENTER**. The Bus Devices list will appear.
3. Select the desired fluid level and press **ENTER**.
4. Choose **LEVEL WRNG** and press **ENTER**. The Level Warning menu will appear with two options: Low Level and High Level.
5. Select the desired warning option and press **ENTER**. The Set Level Percentage window will appear. By default, it will be set to Off. (You can turn off a level warning by setting the Set Level percentage window to Off.)
6. Use the **UP** and **DOWN** keys to set the alarm to the desired percentage of tank capacity. Press **ENTER**. You will be taken back to the Bus Devices list. Press **EXIT** repeatedly to get back to the main display.

NOTE:

If you configure a tank for fuel, you should choose a **LOW LEVEL** warning, which will warn you when the fuel level drops below a preset percentage of the tank's capacity. A Low Level alarm will also work best for Fresh Water and Oil configurations. When a tank is configured for Black Water or Waste Water, the Level Warning should be set to the High Level. If, for example, you set the High Level warning to 75 percent, you would be alerted before the tank's capacity had been exceeded, allowing you to empty the tank before it fills up.

Reset Values

Accessing the Reset Values command from the Fluid Level menu, allows you to reset the values of an individual fluid level without affecting the settings of any other sensor.

To Reset Values:

1. Press **MENU**, use the **UP** and **DOWN** keys to select **SYSTEM SETUP** and press **ENTER**.
2. Highlight **BUS DEVICES** and press **ENTER**. The Bus Devices list will appear.
3. Select the fluid level you want to reset and press **ENTER**. The Fluid Level menu will appear with the following options: Level Warning, Unconfigure, Reconfigure, Calibrate, Reset Cal and Reset Values.
4. Choose **RESET VALUES** and press **ENTER**. The following message will appear: *Press Enter to Reset Device Values*.
5. Press **ENTER** to reset the fluid level's settings back to factory defaults.

NOTE:

If you reset values from a fluid level menu, you will only restore default settings for that particular fluid level sensor. Executing the Reset Values command will also clear configuration and calibration settings.

Suzuki Engine Interface Configuration

You can have up to three Suzuki Engine Interface's installed on your vessel, one for each engine the LMF-400 supports. In a three engine-tank configuration, the interfaces will be listed as Port Engine, Center Engine and Stbd Engine. If the engine interface is unconfigured, it will be listed as Uncfg Eng Int. When accessing an Engine Interface, its menu will appear with the following options: Change Engine (for two or more engines only), Fuel Warning, Unset Engine, Reset Values, Reset Fuel Calibration and Reset Trim Calibration.

NOTE:

If, after configuring, unconfiguring or reconfiguring an engine interface, it is not shown on the Bus Devices list, you will have to refresh the list. Press **MENU**, select **SYSTEM SETUP** and press **ENTER**. Highlight **BUS DEVICES** and press **ENTER**. The Fuel Flow will be listed with its new configuration setting.

To configure a Suzuki Engine Interface:

1. Press **MENU**, use the **UP** and **DOWN** keys to select **SYSTEM SETUP** and press **ENTER**.
2. Highlight **BUS DEVICES** and press **ENTER**. The Bus Devices list will appear.
3. Select **UNCFG ENG INT** and press **ENTER**. The following message will appear: *Press Enter to Configure Eng Intrfc.*
4. Press **ENTER**. The following list of Suzuki engine models will appear: DF40, DF50, DF60, DF70, DF90/115, DF140, DF150, DF175, DF200/225, DF250 and DF300.
5. Select your engine model from the list and press **ENTER**. The Select Engine menu will appear with up to three options (Port, Center and Starboard), depending on your engine-tank configuration. If you chose a single engine configuration during Boat Setup, you will be taken back to the main display.
6. Highlight the engine connected to your engine interface and press **ENTER**. If, for example, you select the Port, the following message will appear: *Press ENTER to change to Port Engine.*
7. Press **ENTER**. You will be taken back to the main display.

To unconfigure a Suzuki Engine Interface:

The unconfigure command (Unset Engine) allows you to set a Suzuki Engine Interface back to its original unconfigured status. Unconfiguring an interface also will allow you to change the engine model selected during configuration.

Unset Engine

1. Press **MENU**, use the **UP** and **DOWN** keys to select **SYSTEM SETUP** and press **ENTER**.
2. Highlight **BUS DEVICES** and press **ENTER** to open the Bus Devices list.
3. Select the desired engine interface and press **ENTER**. The Engine Interface menu will appear. Select **UNSET ENGINE** and press **ENTER**. The following message will appear: *Press Enter to UnConfig Device Name.*
4. Press **ENTER** and you will be directed back to the Bus Devices list., where the engine interface you unconfigured will be shown as UnCfg Intrfc.

NOTE:

If, after configuring, unconfiguring or reconfiguring an engine interface, it is not shown on the Bus Devices list, you will have to refresh the list. Press **MENU**, select **SYSTEM SETUP** and press **ENTER**. Highlight **BUS DEVICES** and press **ENTER**. The Fuel Flow will be listed with its new configuration setting.

To reconfigure Suzuki Engine Interface (multiple engines only):

The Change Engine command is used to switch the current configuration of a Suzuki Engine Interface with the configuration from a different engine. Change Engine, however, will only appear on your LMF-400 menu if you are using an engine-tank configuration that includes multiple engines. If all engine interfaces on your vessel are configured, you will have to unconfigure an interface to free up its configuration name (Port, Center, Starboard).

If all three engine interfaces are configured, leaving no name configuration available, follow the first set of instructions below. If the desired configuration name is available, follow the second set of instructions below.

Change Engine (active only with multiple-engine setting)

The steps below show how to switch the configuration name of an engine interface from the port engine to the starboard engine.

When all engine interfaces are configured (Configuration name unavailable):

1. Press **MENU**, use the **UP** and **DOWN** keys to select **SYSTEM SETUP** and press **ENTER**.

2. Highlight **BUS DEVICES** and press **ENTER**. The Bus Devices list will appear.
3. Select **PORT ENGINE** and press **ENTER**. Highlight **UNSET ENGINE** and press **ENTER**. The following message will appear: *Press Enter to UnConfig Device Name.*
4. Press **ENTER**. You will be taken back to the Bus Devices list, where the interface will now be displayed as UnCfg Intrfc.
5. Select Starboard Engine and press **ENTER**.
6. Highlight **CHANGE ENGINE** and press **ENTER**. The Select Engine menu will appear with up to three options (Port, Center and Starboard), depending on your engine-tank configuration.
7. Select **PORT** and press **ENTER**. You will be taken back to the Bus Devices list.
8. Highlight UnCfg Intrfc and press **ENTER**. The following message will appear: *Press Enter to Configure Eng Intrfc.*
9. Press **ENTER**, which will open the Suzuki Engine Model menu. Select the model of Suzuki engine on your vessel and press **ENTER**. The Select Engine menu will appear with up to three options (Port Center and Starboard).
10. Choose Starboard and press **ENTER**. You will be taken back to the Bus Devices list where the engine interfaces will be shown with their new configuration names.

If desired configuration name available:

1. Press **MENU**, use the **UP** and **DOWN** keys to select **SYSTEM SETUP** and press **ENTER**.
2. Highlight **BUS DEVICES** and press **ENTER**. The Bus Devices list will appear.
3. Select the engine interface you want to reconfigure and press **ENTER**. Highlight **CHANGE ENGINE** and press **ENTER**. The Select Engine menu will appear with up to three options (Port, Center or Starboard), depending on your engine-tank configuration.
4. Choose the desired configuration name and press **ENTER**. You will be taken back to the Bus Devices list, where the engine interface you reconfigured will be displayed with its new configuration name.

Fuel Warning (Fuel Wrng)

Fuel Warning allows you to set a Low level or High level alarm for each Suzuki Engine Interface on the network. A pop-up window will appear if the fuel rises above or falls below a threshold of your choosing.

1. Press **MENU**, use the **UP** and **DOWN** keys to select **SYSTEM SETUP** and press **ENTER**.

2. Highlight **BUS DEVICES** and press **ENTER** to open the Bus Devices list.
3. Select the desired engine interface and press **ENTER**. That will open the Engine Interface menu.
4. Highlight **FUEL WRNG** and press **ENTER**. The Select Level menu will appear with two options: Low Level and High Level. Typically, a Fuel Level warning is used to alert you when your vessel is running low on fuel, so highlight **LOW LEVEL** and press **ENTER**. The Set Level Percentage window will appear, allowing you to set the level warning to the desired percentage of tank capacity (0-100%). It will be set to **OFF** by default. (To turn off a level warning select Off.)
5. Use the **UP** and **DOWN** keys to set the desired fuel warning percentage and press **ENTER**. You will be taken back to the Bus Devices list.

NOTE:

Make sure the fuel flow has been set as the Fuel Remaining Source, otherwise, you will not be able to calibrate the fuel flow. See Fuel Remaining Source instructions on page 28.

Reset Values:

By accessing the Reset Values command from the Engine Interface menu, you will be able to reset configuration and calibration settings for a particular engine interface.

1. Press **MENU**, use the **UP** and **DOWN** keys to select **SYSTEM SETUP** and press **ENTER**.
2. Highlight **BUS DEVICES** and press **ENTER**. Select the engine interface you want to reset and press **ENTER**.
3. Choose **RESET VALUES** from the Engine Interface menu and press **ENTER**. The following message will appear: *Press Enter to Reset Device Values.*
4. Press **ENTER** and you will be taken back to the Bus Devices list, where the engine interface now will be displayed as UnCfg Eng Intrfc.

NOTE:

By resetting values from the configuration menu, **ONLY** the device selected from the Bus Devices list will be set back to its defaults. When you Reset Values, the calibration and configuration settings of the device are set back to factory defaults.

Calibrating EP Sensors

The factory calibration settings for the EP-10 Fuel Flow, EP-15 Fluid Level and Suzuki Engine Interface should be adequate for the majority of applications, so calibration will not be necessary in most cases.

The default calibration for the EP-15 Fluid Level is just as accurate as

standard fluid level gauges. If, however, the tank has an irregular shape or greater accuracy is needed, calibration is recommended.

The default calibration for the EP-10 Fuel Flow and Suzuki Engine Interface are adequate in most cases, but if Fuel Used readings are off by more than 3 percent, calibration is recommended.

Calibrating EP-10 Fuel Flow

The default calibration for an EP-10 Fuel Flow is adequate in most cases, but if fuel used readings are off by more than 3 percent, calibration is recommended.

Fuel Flow Accuracy

To check fuel flow accuracy, add the Fuel Manager page or any of the digital gauge pages to the page screen rotation, then customize the selected page with Fuel Used data. To see instructions on how to Add Pages and Customize Pages, refer to the Operation Section.

NOTE:

Make sure the fuel flow has been set as the Fuel Remaining Source, otherwise, you will not be able to calibrate the fuel flow. See Fuel Remaining Source instructions on page 28.

After filling up your tank, take your vessel out on the water and burn at least five gallons of fuel. **Be sure you run only ONE engine — the engine attached to your fuel flow.**

Fill up your tank again, noting how much fuel you added to the tank. Compare that number to the Fuel Used figure displayed on the page you customized. If the amount of fuel you added to the tank and the fuel used figure are off by more than 3 percent, we recommend the fuel flow be calibrated.

NOTE:

You must use the gauge's Refill Tank command when filling your fuel tank to keep the fuel flow updated with correct information on the amount of fuel in the tank.

Refill Tank

You must use the Refill Tank command every time you fill up and every time you calibrate a fuel flow to make sure the fuel flow reads the tank as full. For more information on the Refill Tank function see page 26.

To calibrate an EP-10 Fuel Flow:

Add the Fuel Manager page or any of the digital gauge pages to the page screen rotation then customize the selected page with Fuel Used data. To see instructions on how to Add Pages and Customize Pages, refer to the Operation Section.

NOTE:

When following the steps below, run only ONE engine — the engine connected to the fuel flow. That is the only way to accurately calculate how much fuel passed through the fuel flow. Also, make sure the fuel remaining source has been set to Eng/FFlow.

1. Fill up the tank you want to calibrate.
2. Press **MENU**, use the **UP** and **DOWN** keys to select **SYSTEM SETUP** and press **ENTER**.
3. Highlight **FUEL SETUP** and press **ENTER**.
3. Select **REFILL TANK** and press **ENTER**. The Select Tank menu will open with up to three options: Port, Center and Starboard.
4. Select the tank you refilled and press **ENTER**. The following message will appear: *Press Enter after refilling the fuel tank.*
5. Press **ENTER** and a calibration window will appear with two options: Yes and No. Select **No** and press **ENTER**.
6. Take your boat out, but run only ONE engine — the engine connected to the fuel flow. Burn at least 5 gallons of fuel, then fill up the tank again, noting how much fuel was added to the tank. Check the Fuel Manager page for the fuel used figure calculated by the LMF-400.
7. Compare the amount of fuel added when you filled up the tank with the LMF-400 Fuel Used figure. If the difference between these two numbers is greater than 3 percent, you need to recalibrate the unit.

NOTE:

If the difference between the LMF-400 fuel used figure and the amount of fuel you actually added to the tank is less than 3 percent, do not recalibrate the EP-10 Fuel Flow.

8. Fill up the fuel tank connected to the fuel flow you want to calibrate.
9. Press **MENU**, use the **UP** and **DOWN** keys to select **SYSTEM SETUP** and press **ENTER**.
10. Highlight **FUEL MANAGER** and press **ENTER**.
11. Select **REFILL TANK** and press **ENTER**. The Select Tank menu will open with three options: Port, Center and Starboard. Select the tank you refilled and press **ENTER**.
12. The Recalibration menu will appear with two options: Yes and No. Select **YES** and press **ENTER**.
13. The Filled Quantity window will appear. Use the **UP** and **DOWN** keys to input the amount of fuel you added to the tank and press **ENTER**.
14. Repeat these steps for each fuel flow you want to calibrate.

NOTE:

It is a good idea to periodically check the calibration of a fuel flow.

Reset Calibration

The Reset Calibration command allows you to set fuel flow calibration back to default settings.

To Reset Calibration for EP-10 Fuel Flow:

1. Press **MENU**, use the **UP** and **DOWN** keys to select **SYSTEM SETUP** and press **ENTER**.
2. Highlight **BUS DEVICES** (Bus Devices) and press **ENTER**. Highlight the fuel flow you want to reset and press **ENTER**.
3. Select **RESET CAL** from the fuel flow menu and press **ENTER**. The following message will appear: *Press Enter to reset the Calibration.*
4. Press **ENTER** to set calibration back to default settings. To recalibrate the fuel flow, follow the steps in the previous segment regarding fuel flow calibration.

Partial Fill

You will use the Partial Fill option each time you add fuel without filling up the tank.

To use Partial Fill:

1. Scroll through the pages until the Fuel Manager page is on the screen, then press **MENU**.
2. Use the **UP** and **DOWN** keys to highlight **SYSTEM SETUP** and press **ENTER**.
3. Select **FUEL SETUP** and press **ENTER**.
4. Choose **PARTIAL FILL** and press **ENTER**. If you have more than one tank, the Select Tank menu will appear with up to three options (Port, Center and Starboard), depending on your engine-tank configuration. (If you have one tank, you will be taken directly to the Adding Fuel window.)
5. Highlight the tank you partially filled and press **ENTER**. That will open the Adding Fuel window.
6. Use the **UP** and **DOWN** keys to enter the amount of fuel you added to the tank and press **ENTER**. You will be taken back to the main display.

Calibrating EP-15 Fluid Level

The default calibration for the EP-15 Fluid Level is just as accurate as standard fluid level gauges. If, however, the tank has an irregular shape or greater accuracy is needed, calibration is recommended.

The EP-15 Fluid Level has three calibration options: 2 point, 3 point and 5 point.

2-Point Calibration

A 2-point calibration is best suited for rectangular or square-shaped tanks, where the capacity of the top half of the tank matches the capacity in the lower half of the tank. In a two-point calibration, you will set two points, one each for empty and full levels. You can begin calibration at either of the two points, but we recommend starting with an empty tank. You will fill the tank to complete calibration.

NOTE:

You DO NOT have to calibrate both points to complete the calibration and you can calibrate the points (Empty Level and Full Level) in any order you wish. *Remember: Points that are not calibrated will not be as accurate as points that have been calibrated.* For the greatest accuracy, we recommend both points be calibrated.

To execute 2-Point calibration:

1. Before following the steps below, make sure your fuel tank is empty.
2. Press **MENU**, use the **UP** and **DOWN** keys to select **SYSTEM SETUP** and press **ENTER**.
3. Highlight **BUS DEVICES** and press **ENTER**. Choose the fluid level you want to calibrate and press **ENTER**.
4. Select **CALIBRATE** and press **ENTER**. The Number of Points menu will appear with three options: 2, 3 and 5. Select **2**, for two-point calibration, and press **ENTER**.
5. The Levels menu will appear with two choices: Empty Level and Full Level. Choose **EMPTY LEVEL** and press **ENTER**.
6. The following message will appear: *Set Tank to Empty Level Press Enter*. Press **ENTER**. You will be taken back to the Levels menu.
7. Fill up your tank.
8. Select **FULL LEVEL** and press **ENTER**. The following message will appear: *Set Tank to Full Level Press Enter*.
9. Press **ENTER**. Press **EXIT** repeatedly to return to the main display.

3-Point Calibration

3-point calibration is designed for tanks that vary in shape from the top to the bottom. You can begin calibration at any point in the 3-point process, but we recommend starting calibration with an empty tank. In a 3-point calibration, you will set three points, one each for empty, half and full levels.

NOTE:

You DO NOT have to calibrate all three points to complete the calibration and you can calibrate the points (Empty Level, Half

Level and Full Level) in any order you wish. *Remember: Points that are not calibrated will not be as accurate as points that have been calibrated.* For the greatest accuracy, we recommend all three points be calibrated.

To execute 3-Point calibration:

1. Before following the steps below, make sure your fuel tank is empty.
2. Press **MENU**, use the **UP** and **DOWN** keys to select **SYSTEM SETUP** and press **ENTER**.
3. Highlight **BUS DEVICES** and press **ENTER**. Choose the fluid level you want to calibrate and press **ENTER**.
4. Select **CALIBRATE** and press **ENTER**. The Number of Points menu will appear with three options: 2, 3 and 5. Select **3**, for three-point calibration, and press **ENTER**.
5. Highlight **EMPTY LEVEL** and press **ENTER**. The following message will appear: *Set Tank to Empty Level Press Enter.*
6. Press **ENTER**. You will be taken back to the Levels menu.
7. Add half a tank of fuel. (If you had a 100 gallon tank, you would add 50 gallons.)
8. Select **HALF LEVEL** and press **ENTER**. The following message will appear: *Set Tank to Half Level Press Enter.*
9. Press **ENTER**. You will be taken back to the Levels menu.
10. Fill up your tank.
11. Highlight **FULL LEVEL** and press **ENTER**. The following message will appear: *Set Tank to Full Level Press Enter.*
12. Press **ENTER**. You will be taken back to the Levels menu. Press **EXIT** repeatedly to get back to the main display.

5-Point Calibration

5-point calibration is best suited tanks that vary greatly in shape from top to bottom. You can begin calibration at any point in the 5-point calibration process. We recommend starting calibration with an empty tank. In a five-point calibration there are five calibration points: Empty Level, 1 Qtr Level, Half Level, 3 Qtr Level and Full Level.

NOTE:

You DO NOT have to calibrate all five points to complete the calibration and you can calibrate the points (Empty Level, 1 Quarter Level, Half Level, 3 Quarter Level and Full Level) in any order you wish. *Remember: Points that are not calibrated will not be as accurate as points that have been calibrated.* For the greatest accuracy, we recommend all five points be calibrated.

To execute 5-Point calibration:

1. Before following the steps below, make sure your fuel tank is empty. Press **MENU**, use the up and down keys to select **SYSTEM SETUP** and press **ENTER**.
2. Highlight **BUS DEVICES** and press **ENTER**. Choose the fluid level you want to calibrate and press **ENTER**. Select **CALIBRATE** and press **ENTER**. The Number of Points menu will appear with three options: 2, 3 and 5. Select **5**, for three-point calibration, and press **ENTER**.
3. The Levels menu will appear with five options: Empty Level, 1 Qtr Level, Half Level, 3 Qtr Level and Full level. Select **EMPTY LEVEL** and press **ENTER**. The following message will appear: *Set Tank to Empty Level Press Enter*.
4. Press **ENTER**. You will be taken back to the Levels menu. Add 1-quarter tank of fuel. (If you have a 100 gallon tank, add 25 gallons of fuel.)
5. Highlight **1 QTR LEVEL** and press **ENTER**. The following message will appear: *Set Tank to 1 Qtr Level Press Enter*.
6. Press **ENTER**. You will be taken back to the Levels menu. Fill your tank up halfway. (If you have a 100 gallon tank, add another 25 gallons of fuel.)
7. Highlight **HALF LEVEL** and press **ENTER**. The following message will appear: *Set Tank to Half Level Press Enter*. Press **ENTER**. You will be taken back to the Levels menu.
8. Fill your tank to the 3 quarter level. (If you have a 100 gallon tank, add another 25 gallons of fuel.) Highlight **3 QTR LEVEL** and press **ENTER**. The following message will appear: *Set Tank to 3 Qtr Level Press Enter*.
9. Press **ENTER**. You will be taken back to the Levels menu. Fill up your tank, then select **FULL LEVEL** and press **ENTER**. The following message will appear: *Set Tank to Full Level Press Enter*.
10. Press **ENTER**. You will be taken back to the Levels menu. Press **EXIT** repeatedly to get back to the main display.

Reset Calibration

The Reset Calibration command allows you to reset a fuel flow back to factory default settings. You will only need to reset calibration when you believe your fuel flow has been calibrated incorrectly.

To Reset Calibration:

1. Press **MENU**, select **SYSTEM SETUP** and press **ENTER**.
2. Highlight **BUS DEVICES** and press **ENTER**. Select the fluid level you want to reset and press **ENTER**.

3. Highlight **RESET CAL** from the fluid level menu and press **ENTER**. The following message will appear: *Press Enter to reset Calibration.*
4. Press **ENTER** to set calibration back to factory default settings. You, then, will be returned to the bus devices list.

NOTE:

If you have calibrated your fluid level sensor and are having problems with the sensor's performance, be sure to check the sending unit. You can do this by using an ohm meter to test the resistance of the unit. Connect the sending unit hot wire (usually pink) and the ship or sending unit ground wire (usually black) to the ohm meter. With the tank full, the resistance should be around 33-1/2 ohms. When the tank is the empty, the resistance should be around 240 ohms. If, when the tank is full or empty, the ohm readings are significantly different from the standard full (33-1/2) and empty (240) ohms levels, there is a problem with the sending unit. If the ohm readings are the same in both cases, the sending unit is stuck.

Calibrating Fuel Flow in a Suzuki Engine Interface

The default calibration for a Suzuki Engine Interface is adequate in most cases, but if fuel used readings are off by more than 3 percent, calibration is recommended.

Engine Interface Accuracy

To check the accuracy of an engine interface, add the Fuel Manager page or any of the digital gauge pages to the page screen rotation, then customize the selected page to show Fuel Used data. To see instructions on how to Add Pages and Customize Pages, refer to the Operation Section.

NOTE:

Make sure the fuel flow has been set as the Fuel Remaining Source, otherwise, you will not be able to calibrate the fuel flow. See Fuel Remaining Source instructions on page 28.

After filling up your tank, take your vessel out on the water and burn at least five gallons of fuel. **Be sure you run only ONE engine — the engine connected to the engine interface.**

Fill up your tank again, noting how much fuel you added to the tank. Compare that number to the Fuel Used figure displayed on the page you customized. If the amount of fuel you added to the tank and the fuel used figure are off by more than 3 percent, we recommend the engine interface be calibrated.

NOTE:

You must use the gauge's Refill Tank command when filling your fuel tank to keep the engine interface updated with correct information on the amount of fuel in the tank.

Refill Tank

You must use the Refill Tank command every time you fill up and every time you calibrate an engine interface to make sure the engine interface reads the tank as full. For more information on the Refill Tank function see page 26.

To calibrate a Suzuki Engine Interface:

Add the Fuel Manager page or any of the digital gauge pages to the page screen rotation. Customize the page you added to show Fuel Used data. To see instructions on how to Add Pages and Customize Pages, refer to the Operation Section.

NOTE:

When following the steps below, run only ONE engine — the engine connected to the engine interface.

1. Fill up the tank connected to the engine you want to calibrate.
2. Press **MENU**, use the **UP** and **DOWN** keys to select **SYSTEM SETUP** and press **ENTER**.
3. Highlight **FUEL SETUP** and press **ENTER**.
3. Select **REFILL TANK** and press **ENTER**. The Select Tank menu will open with up to three options: Port, Center and Starboard.
4. Select the tank you refilled and press **ENTER**. The ReCalibration menu will appear with two options: Yes and No. Select **No** and press **ENTER**. The following message will appear: *Press Enter after refilling the fuel tank.*
5. Press **ENTER**. Take your boat out, but run only ONE engine — the engine connected to the engine interface Burn at least 5 gallons of fuel, then fill up the tank again, noting how much fuel was added to the tank. Check the Fuel Manager page for the fuel used figure calculated by Suzuki Engine Interface.
6. Compare the amount of fuel added when you filled up the tank with the Fuel Used figure shown on the LMF-400. If the difference between these two numbers is greater than 3 percent, you need to calibrate the interface.

NOTE:

If the difference between the LMF-400 fuel used figure and the amount of fuel you actually added to the tank is less than 3 percent, do not calibrate the engine interface.

7. Press **MENU**, use the **UP** and **DOWN** keys to select **SYSTEM SETUP** and press **ENTER**.
8. Highlight **FUEL SETUP** and press **ENTER**.
9. Select **REFILL TANK** and press **ENTER**. The Select Tank menu will open with up to three options (Port, Center and Starboard), depending on your engine-tank configuration. Select the tank you refilled and press **ENTER**.
10. The Recalibration menu will appear with two options: Yes and No. Select **Yes** and press **ENTER**.
11. The Filled Quantity window will appear. Use the **UP** and **DOWN** keys to input the amount of fuel you added and press **ENTER**. You will be taken back to the main display.
12. Repeat these steps for each engine interface you want to calibrate.

NOTE:

The LMF-400 will not let you input an amount of fuel greater than the fuel used figure.

Reset Fuel Calibration

The Reset Calibration command allows you to reset engine interface calibration back to default settings.

To reset Calibration for Suzuki Engine Interface:

1. Press **MENU**, use the **UP** and **DOWN** keys to select **SYSTEM SETUP** and press **ENTER**.
2. Highlight **Bus DEVICES** and press **ENTER**. Highlight the engine interface you want to reset and press **ENTER**.
3. Select **RST FUEL CAL** from the engine interface menu and press **ENTER**. The following message will appear: *Press Enter to reset the Fuel Cal.*
4. Press **ENTER** to set calibration back to default settings. To recalibrate the engine interface, follow the steps in the previous segment regarding engine interface calibration.

Partial Fill

You will use the Partial Fill option each time you add fuel but do not fill up the tank.

To use Partial Fill:

1. Use the **UP** and **DOWN** keys to highlight **SYSTEM SETUP** and press **ENTER**.
2. Select **FUEL SETUP** and press **ENTER**.
3. Choose **PARTIAL FILL** and press **ENTER**. If you have more than one tank, the Select Tank menu will appear. (If you have one tank, you will be taken directly to the Adding Fuel window.)

4. Highlight the tank you partially filled and press **ENTER**. That will open the Adding Fuel window.
5. Use the **UP** and **DOWN** keys to enter the amount of fuel you added to the tank and press **ENTER**. You will be taken back to the main display.

Calibrating EP-30 Trim Tabs

Trim Tabs are calibrated through the Trim Tab pages menu. If the Trim Tab page is not displayed in the page screen rotation, refer to Section 2: Operation section for information on how to add the Trim Tab page to the page screen rotation.

To calibrate Trim Tabs:

1. Make sure the Trim Tabs page is on the main display
2. Press **MENU**, select **CALIBRATE TAB** and press **ENTER**. The following message will appear: *Bring Tabs Full Up Press Enter*.
3. Adjust the position of the Trim Tabs to the Full Up Position and press **ENTER**. A second message will appear: *Run Tabs Full DN (Down)*.
4. Move the Trim Tabs into the full down position. The Trim Tabs are now calibrated. Press **EXIT**. You will be taken back to the main display.



Trim Tabs menu (left). When calibrating Trim Tabs, the Full Up message (center) appears first. It is followed by the Run Tabs Full Down message (right).

Notes

LOWRANCE ELECTRONICS FULL ONE-YEAR WARRANTY

"We," "our," or "us" refers to LOWRANCE ELECTRONICS, INC., the manufacturer of this product. "You" or "your" refers to the first person who purchases this product as a consumer item for personal, family or household use.

We warrant this product against defects or malfunctions in materials and workmanship, and against failure to conform to this product's written specifications, all for one (1) year from the date of original purchase by you. **WE MAKE NO OTHER EXPRESS WARRANTY OR REPRESENTATION OF ANY KIND WHATSOEVER CONCERNING THIS PRODUCT.** Your remedies under this warranty will be available so long as you can show in a reasonable manner that any defect or malfunction in materials or workmanship, or any non-conformity with the product's written specifications, occurred within one year from the date of your original purchase, which must be substantiated by a dated sales receipt or sales slip. Any such defect, malfunction, or non-conformity which occurs within one year from your original purchase date will either be repaired without charge or be replaced with a new product identical or reasonably equivalent to this product, at our option, within a reasonable time after our receipt of the product. If such defect, malfunction, or non-conformity remains after a reasonable number of attempts to repair by us, you may elect to obtain without charge a replacement of the product or a refund for the product. **THIS REPAIR, OR REPLACEMENT OR REFUND (AS JUST DESCRIBED) IS THE EXCLUSIVE REMEDY AVAILABLE TO YOU AGAINST US FOR ANY DEFECT, MALFUNCTION, OR NON-CONFORMITY CONCERNING THE PRODUCT OR FOR ANY LOSS OR DAMAGE RESULTING FROM ANY OTHER CAUSE WHATSOEVER. WE WILL NOT UNDER ANY CIRCUMSTANCES BE LIABLE TO ANYONE FOR ANY SPECIAL, CONSEQUENTIAL, INCIDENTAL, OR OTHER INDIRECT DAMAGE OF ANY KIND.**

Some states do not allow the exclusion or limitation of incidental or consequential damages, so the above limitations or exclusions may not apply to you.

This warranty does NOT apply in the following circumstances: (1) when the product has been serviced or repaired by anyone other than us; (2) when the product has been connected, installed, combined, altered, adjusted, or handled in a manner other than according to the instructions furnished with the product; (3) when any serial number has been effaced, altered, or removed; or (4) when any defect, problem, loss, or damage has resulted from any accident, misuse, negligence, or carelessness, or from any failure to provide reasonable and necessary maintenance in accordance with the instructions of the owner's manual for the product.

We reserve the right to make changes or improvements in our products from time to time without incurring the obligation to install such improvements or changes on equipment or items previously manufactured.

This warranty gives you specific legal rights and you may also have other rights which may vary from state to state.

REMINDER: You must retain the sales slip or sales receipt proving the date of your original purchase in case warranty service is ever required.

**LOWRANCE ELECTRONICS
12000 E. SKELLY DRIVE, TULSA, OK 74128
(800) 324-1356**

How to Obtain Service...

...in the USA:

We back your investment in quality products with quick, expert service and genuine Lowrance parts. If you're in the United States and you have technical, return or repair questions, please contact the Factory Customer Service Department. Before any product can be returned, you must call customer service to determine if a return is necessary. Many times, customer service can resolve your problem over the phone without sending your product to the factory. call us, use the following toll-free number:

800-324-1356

8 a.m. to 5 p.m. Central Standard Time, M-F

Lowrance Electronics may find it necessary to change or end our shipping policies, regulations, and special offers at any time. We reserve the right to do so without notice.

...in Canada:

If you're in Canada and you have technical, return or repair questions, please contact the Factory Customer Service Department. Before any product can be returned, you must call customer service to determine if a return is necessary. Many times, customer service can resolve your problem over the phone without sending your product to the factory. call us, use the following toll-free number:

800-661-3983

905-629-1614 (not toll-free)

8 a.m. to 5 p.m. Eastern Standard Time, M-F

...outside Canada and the USA:

If you have technical, return or repair questions, contact the dealer in the country where you purchased your unit. To locate a dealer near you, visit our web site, www.lowrance.com and look for the Dealer Locator.

Accessory Ordering Information for all countries

To order Lowrance accessories such as power cables or transducers, please contact:

1) Your local marine dealer or consumer electronics store. Most quality dealers that handle marine electronic equipment or other consumer electronics should be able to assist you with these items.

To locate a Lowrance dealer near you, visit our web site, www.lowrance.com and look for the Dealer Locator. Or, you can consult your telephone directory for listings.

2) U.S. customers: LEI Extras Inc., PO Box 129, Catoosa, OK 74015-0129
Call 1-800-324-0045 or visit our web site www.lei-extras.com.

3) Canadian customers can write:

Lowrance/Eagle Canada, 919 Matheson Blvd. E. Mississauga, Ontario L4W2R7 or fax 905-629-3118.

Shipping Information

If it becomes necessary to send a product for repair or replacement, you must first receive a return authorization number from Customer Service. Products shipped without a return authorization will not be accepted. When shipping, we recommend you do the following:

- 1.** Please do not ship the knobs or mounting bracket with your unit.
- 2.** If you are sending a check for repair, please place your check in an envelope and tape it to the unit.
- 3.** For proper testing, include a brief note with the product describing the problem. Be sure to include your name, return shipping address and a daytime telephone number. An e-mail address is optional but useful.
- 4.** Pack the unit in a suitable size box with packing material to prevent any damage during shipping.
- 5.** Write the Return Authorization (RA) number on the outside of the box underneath your return address.
- 6.** For your security, you may want to insure the package through your shipping courier. Lowrance does not assume responsibility for goods lost or damaged in transit.



Visit our web site:



Lowrance Pub. 988-0151-222

Printed in USA 121306

© Copyright 2006
All Rights Reserved
Lowrance Electronics, Inc.